

SKRIV & BYG

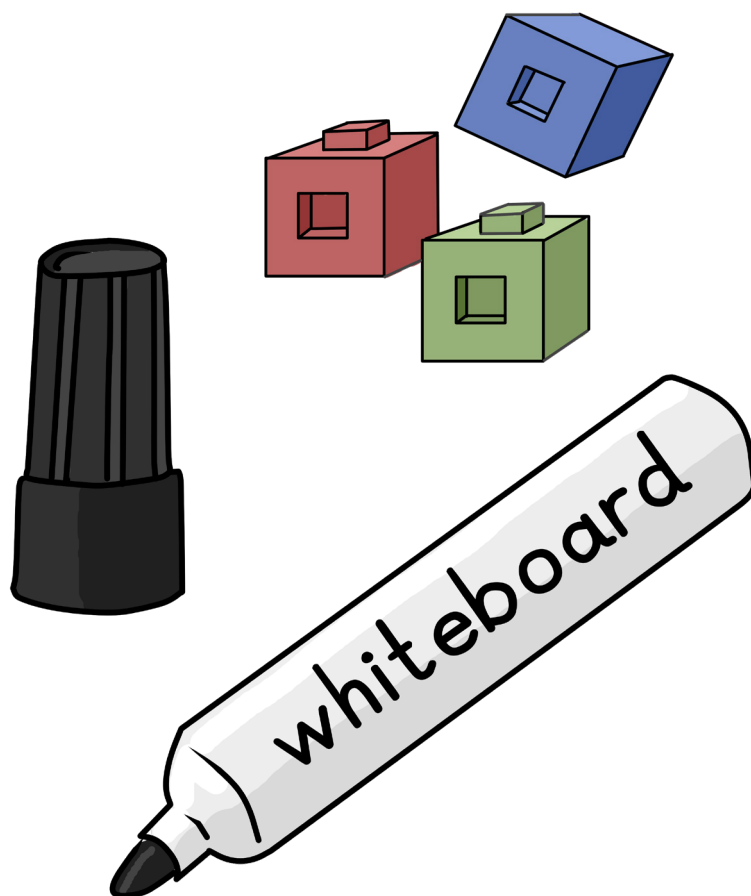

Skriv

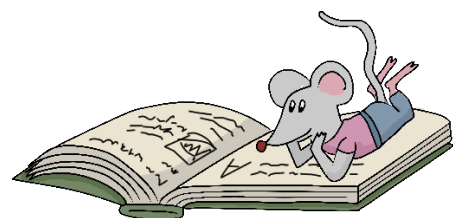
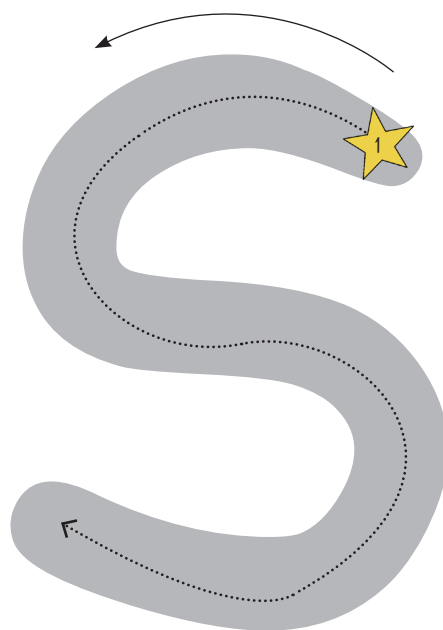
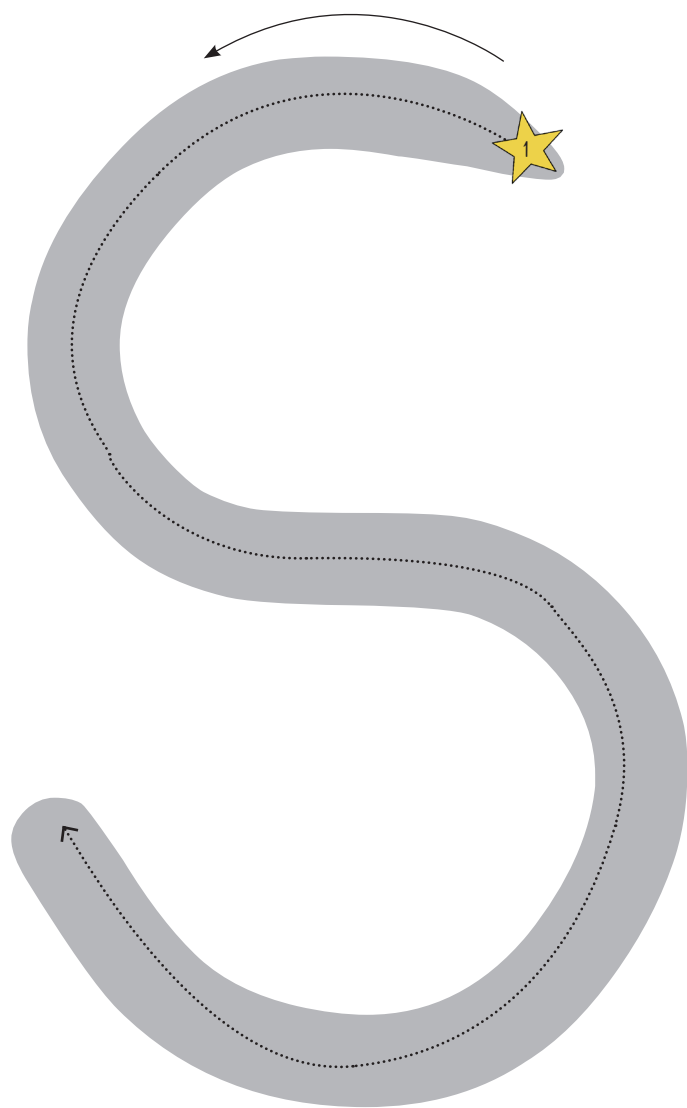

Byg

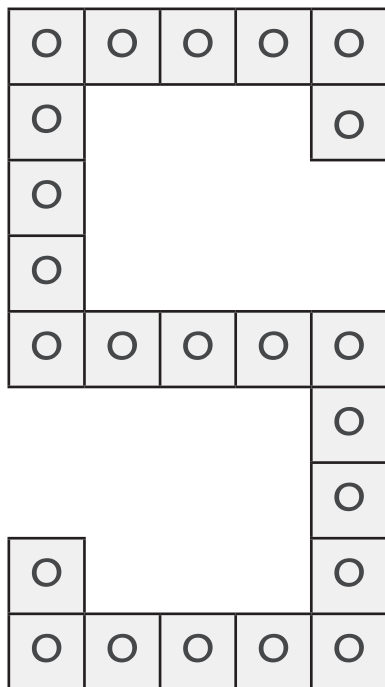

Find

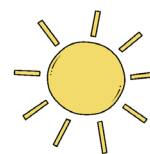
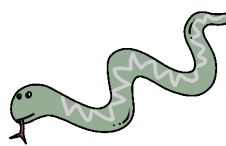
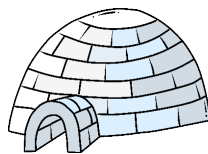
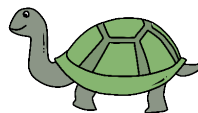
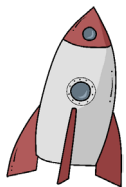
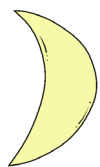

Skriv

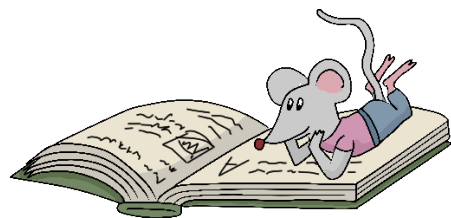
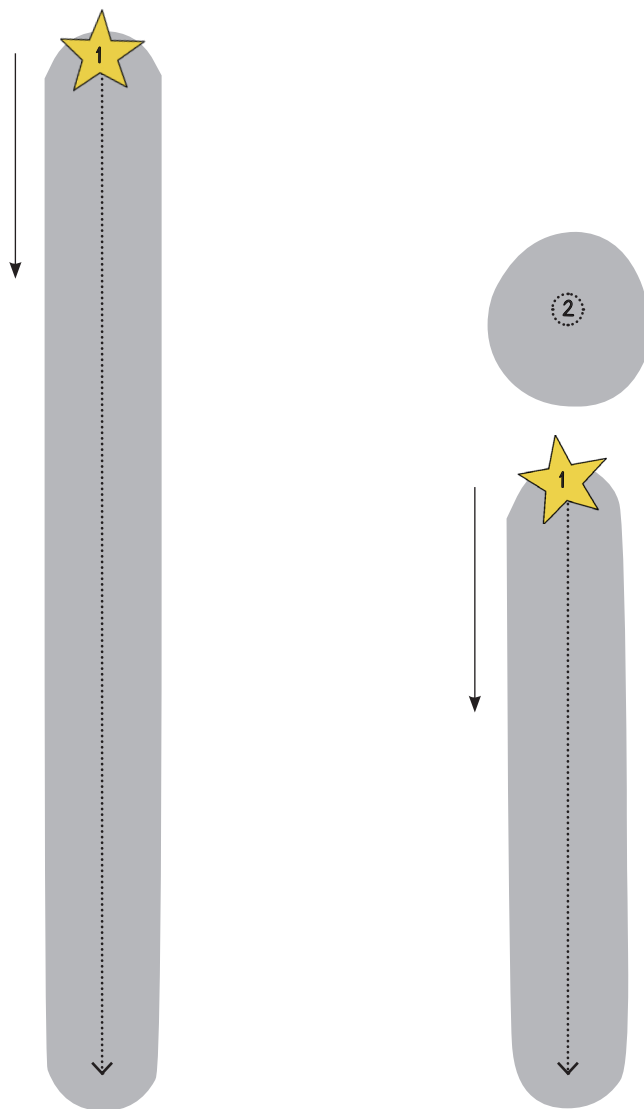

Byg

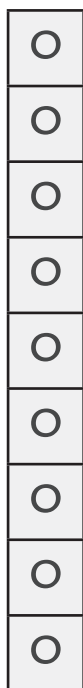

Find

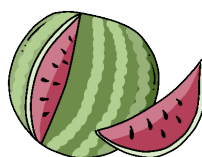
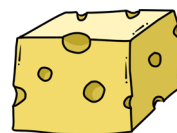
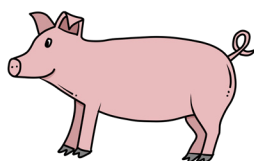
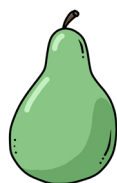
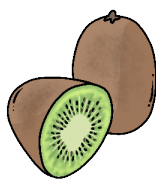
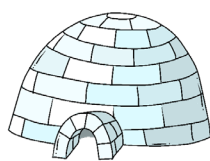
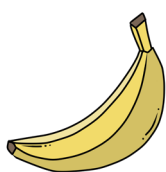

Skriv

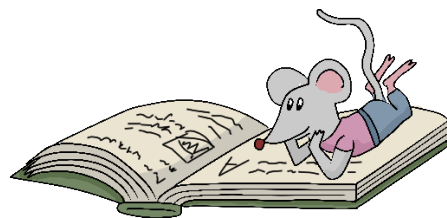
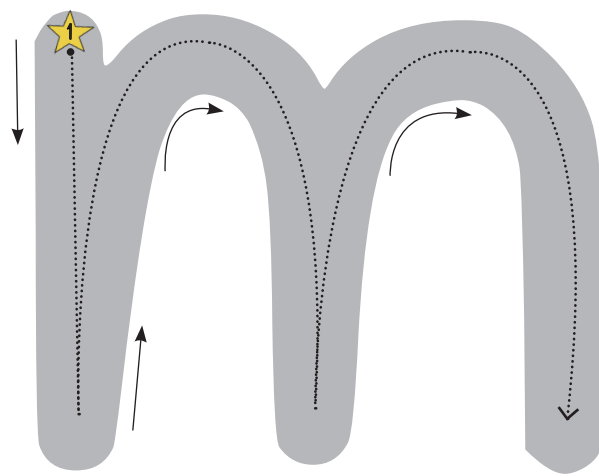
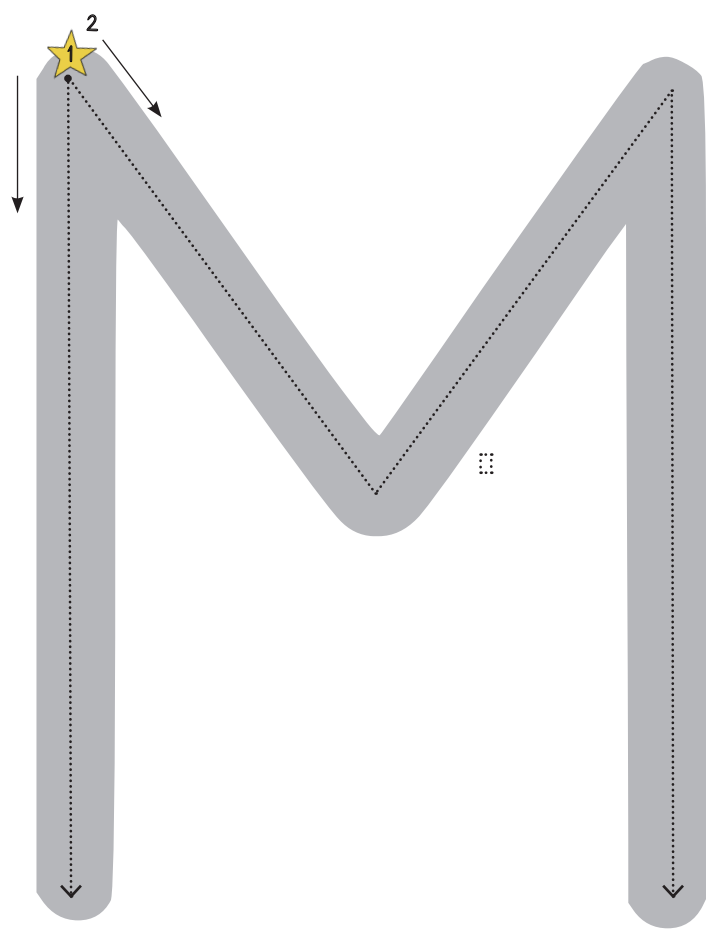

Byg

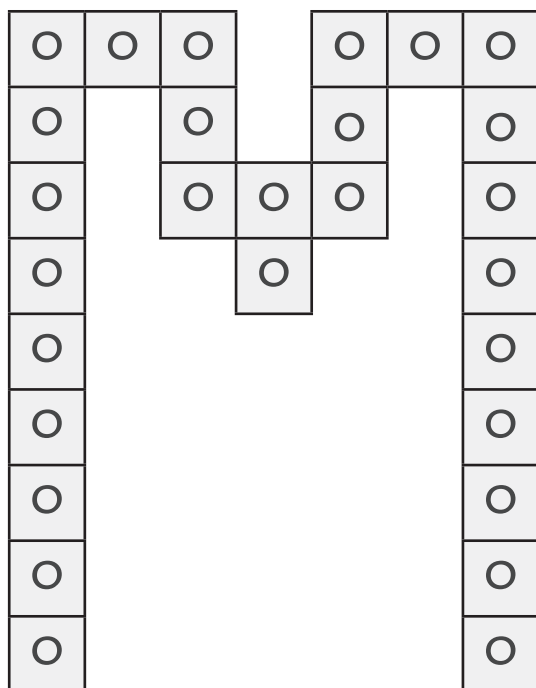

Find

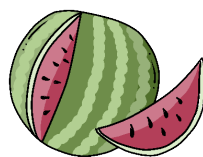
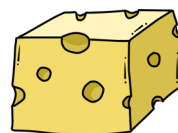
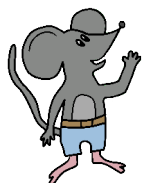
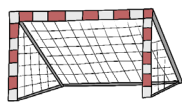
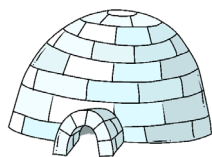

Skriv

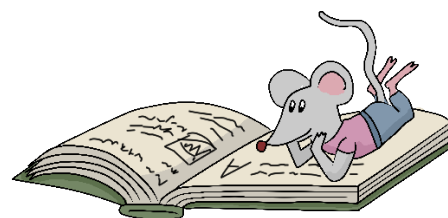
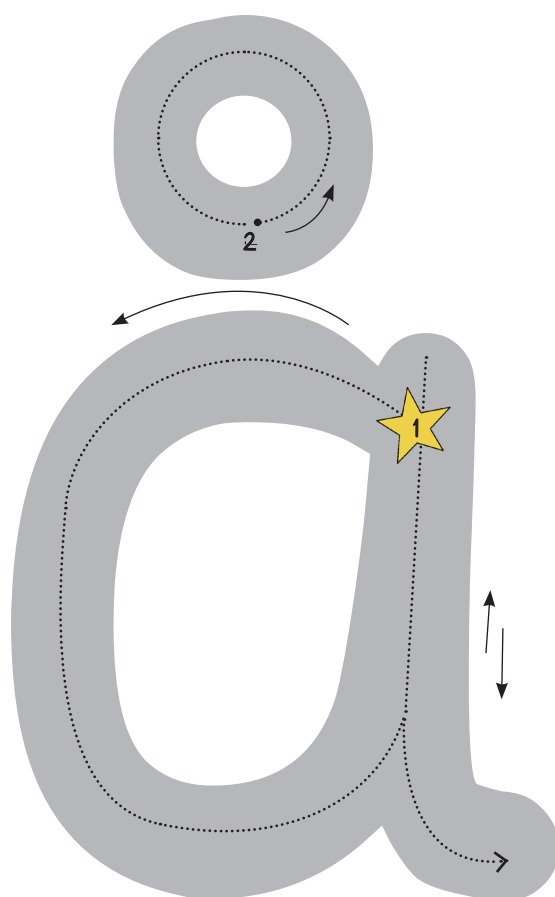
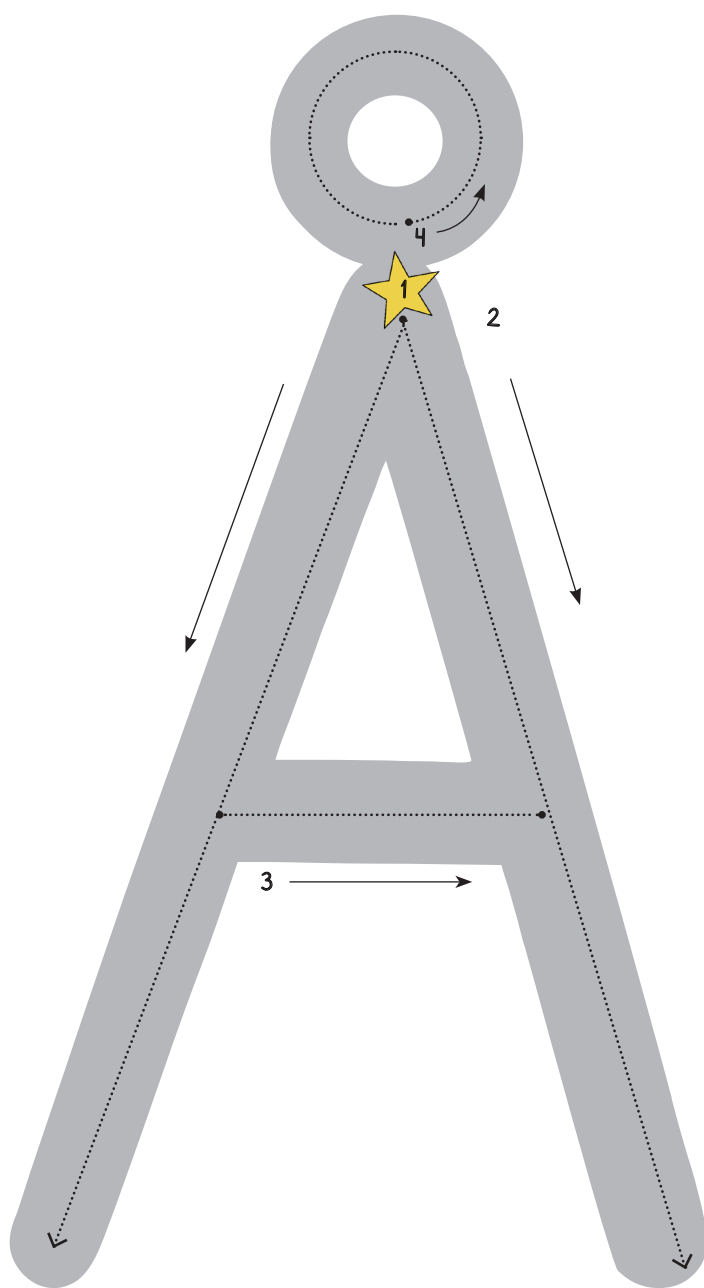

Byg

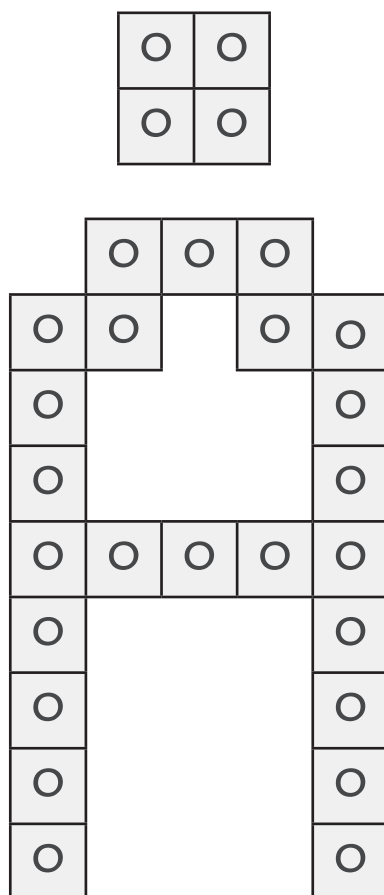

Find

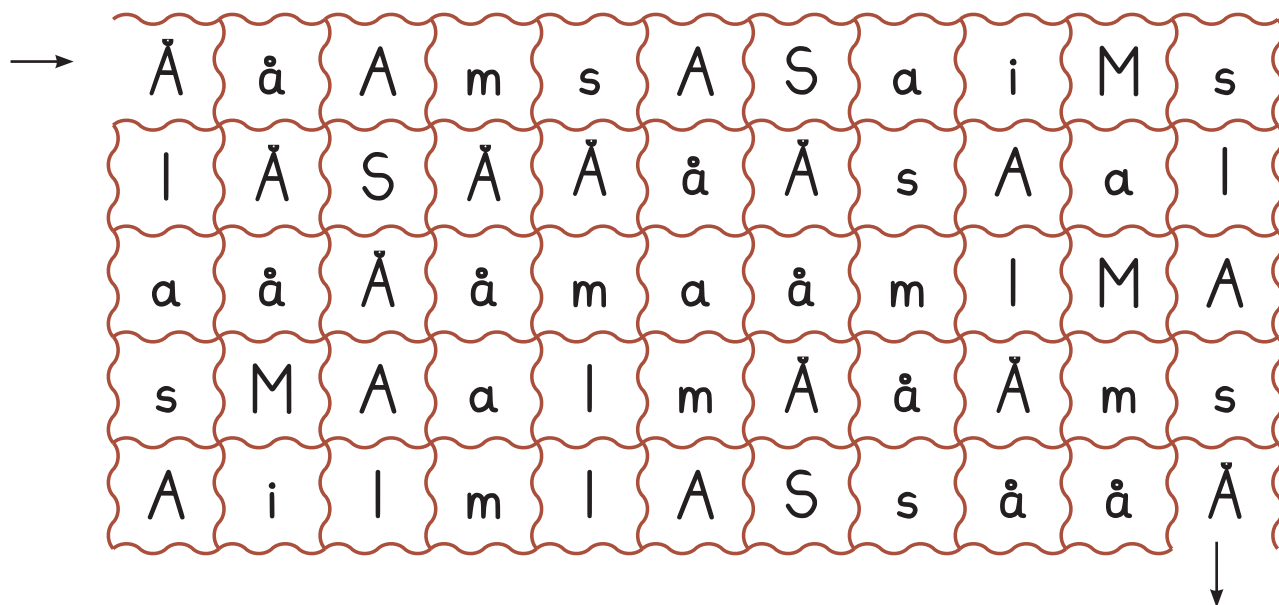

Skriv

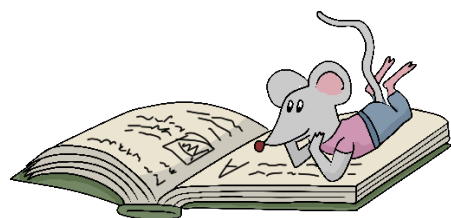
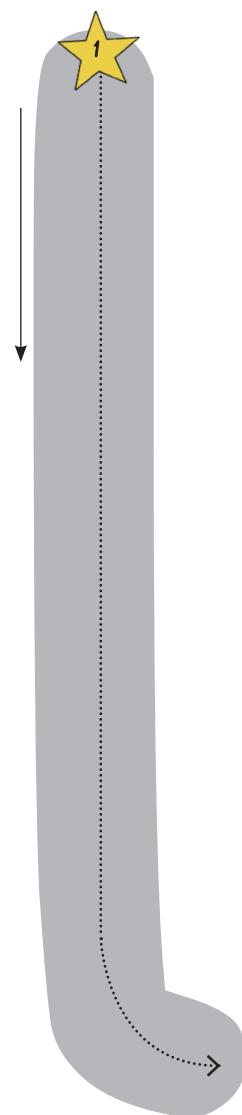
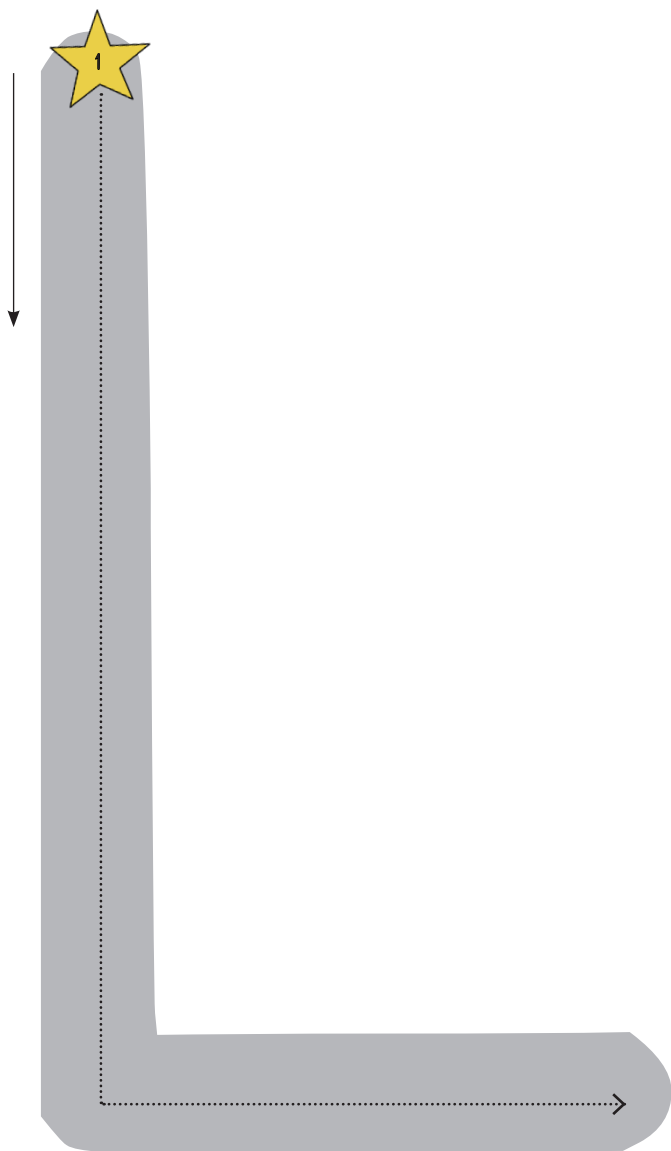

Byg

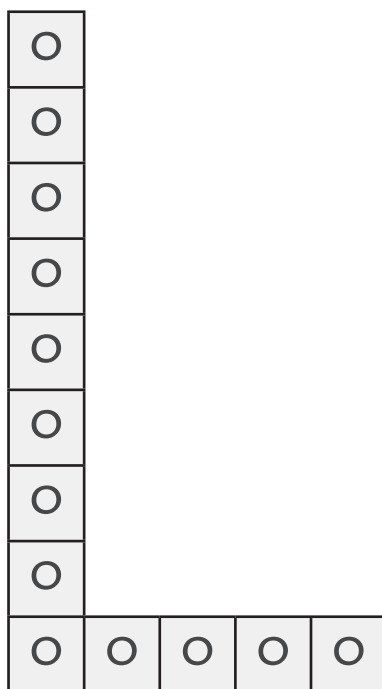

Find

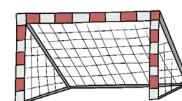
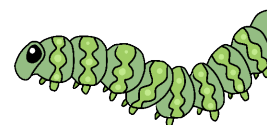
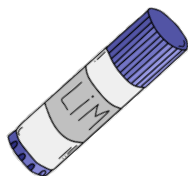

Skriv

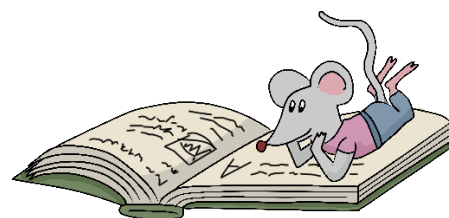
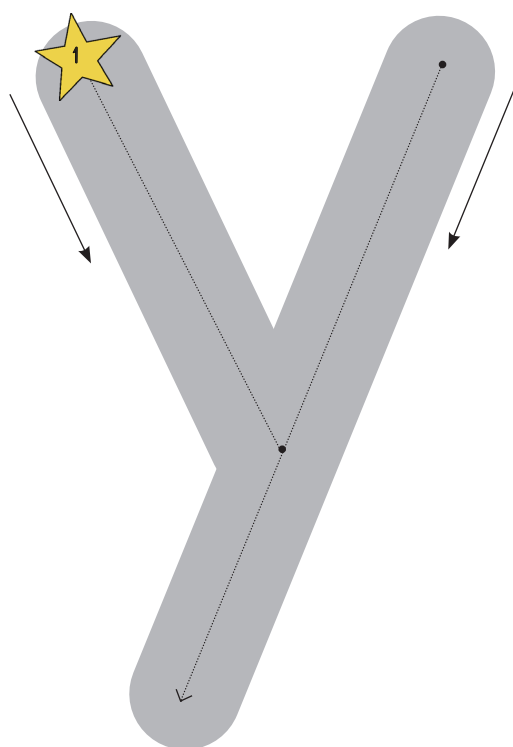
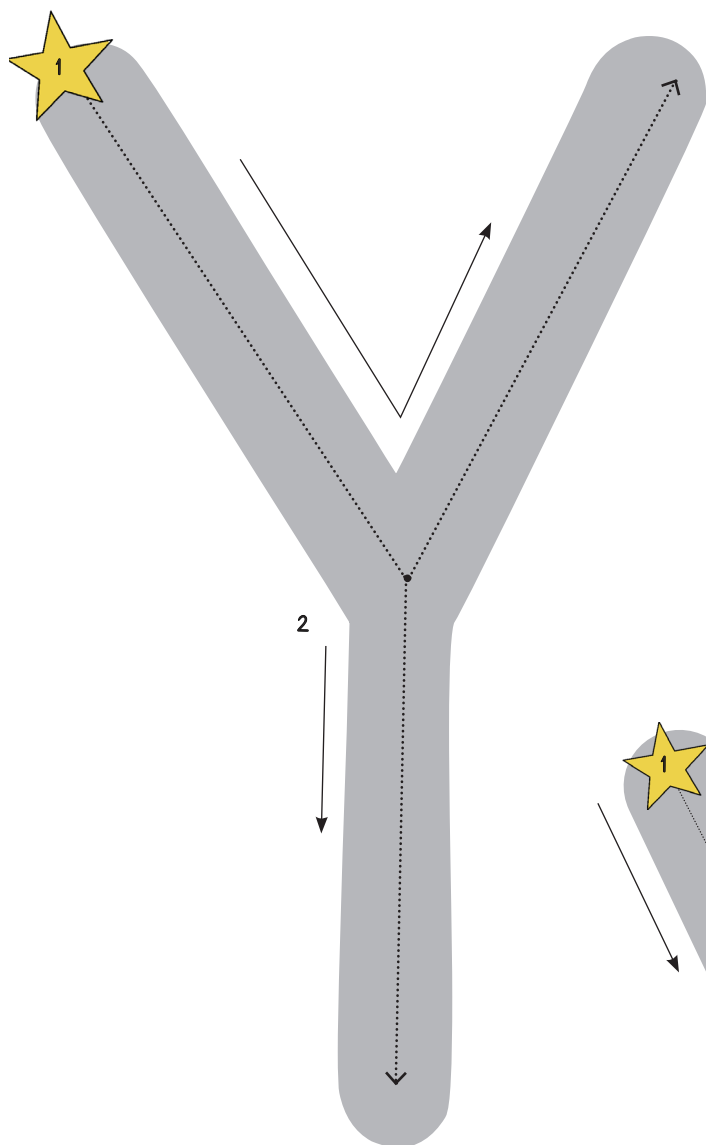

Byg

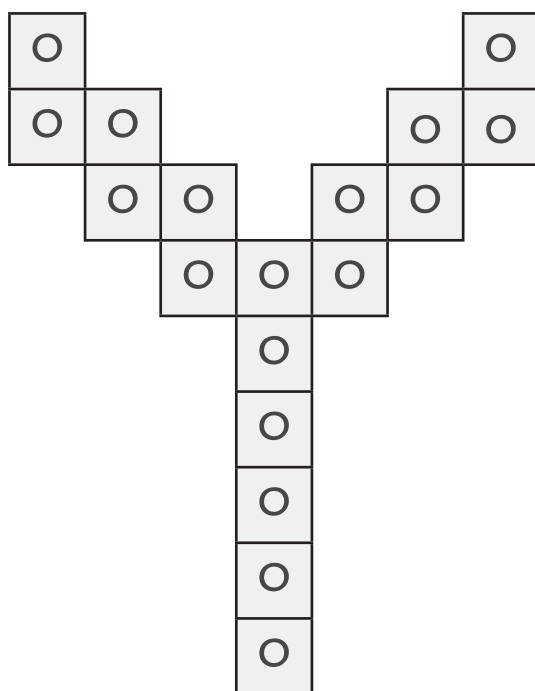

Find

↓

Å	Y	y	y	s	Y	S	a	i	M	s
l	Y	S	y	Y	y	Å	Y	y	Y	y
a	y	Å	å	m	a	å	y	l	M	Y
s	y	Y	a	y	Y	Y	y	Å	Y	y
A	M	y	y	Y	A	S	s	å	y	Å

↓

Skriv

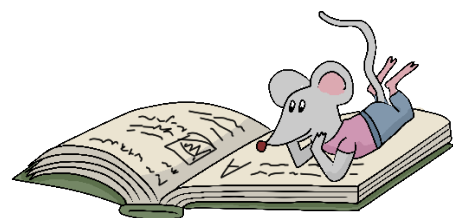
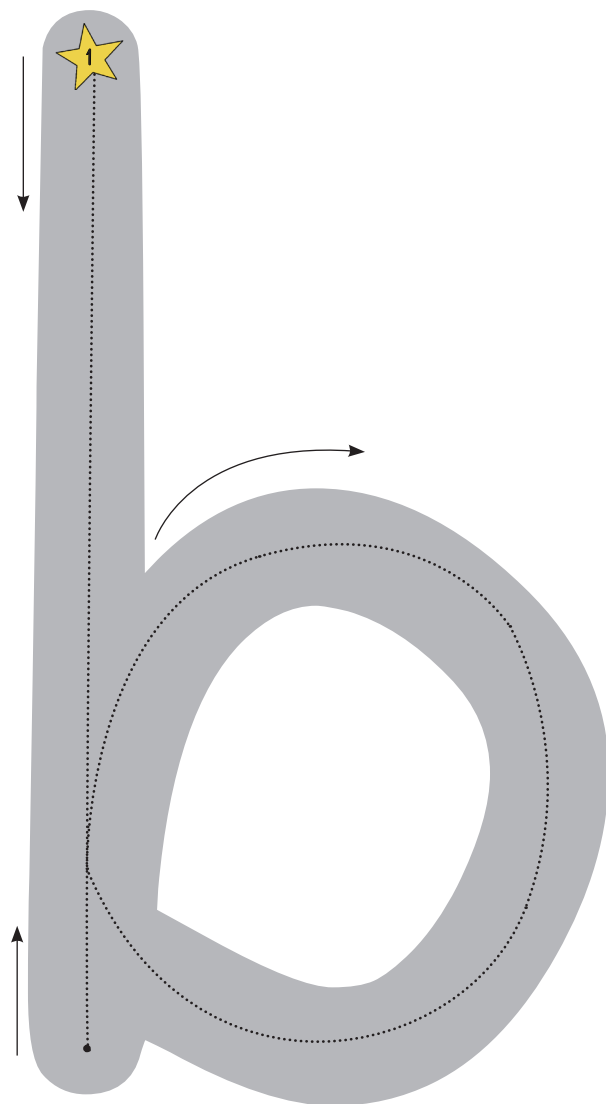
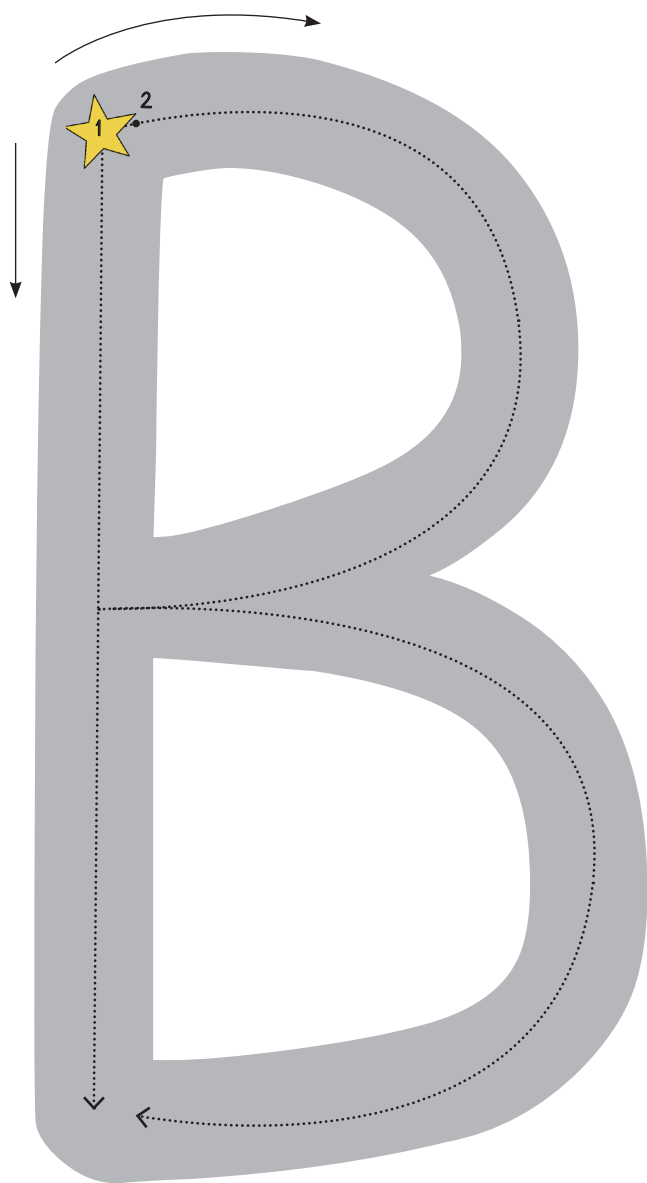

Byg

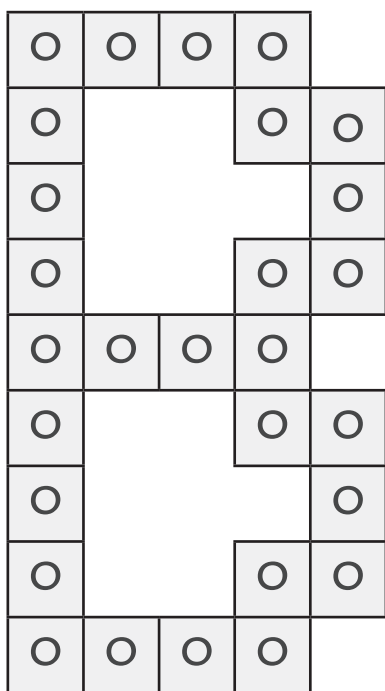

Find

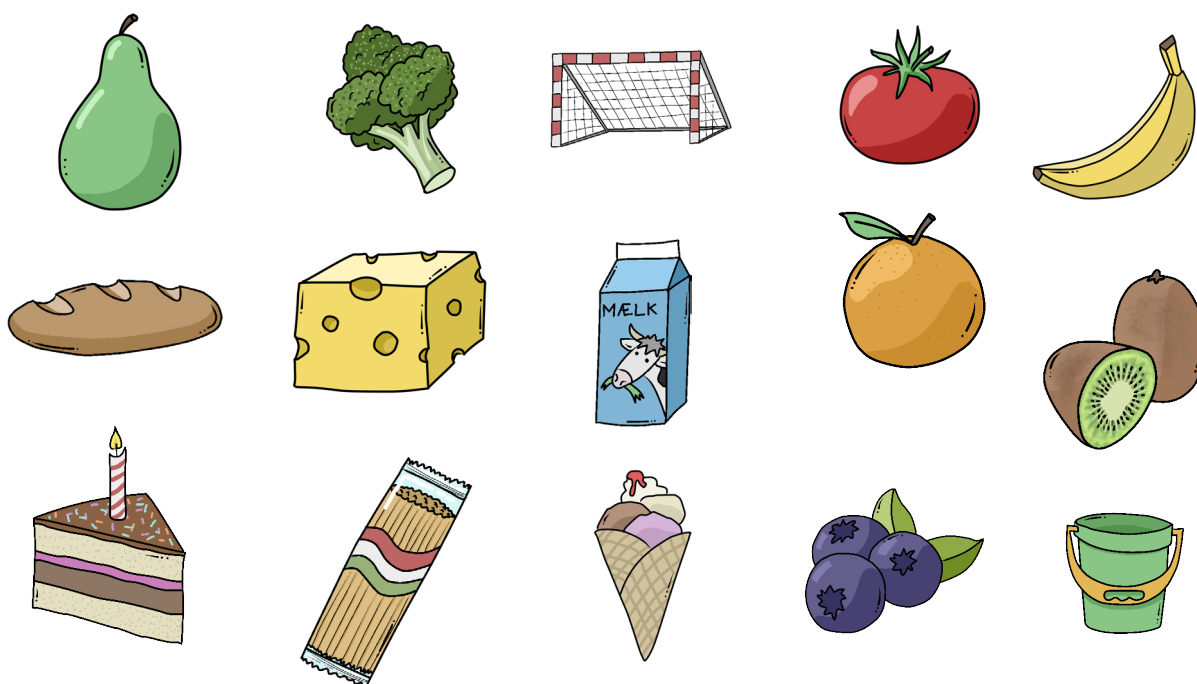

Skriv

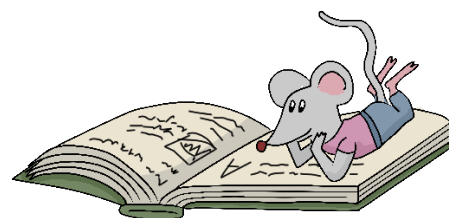
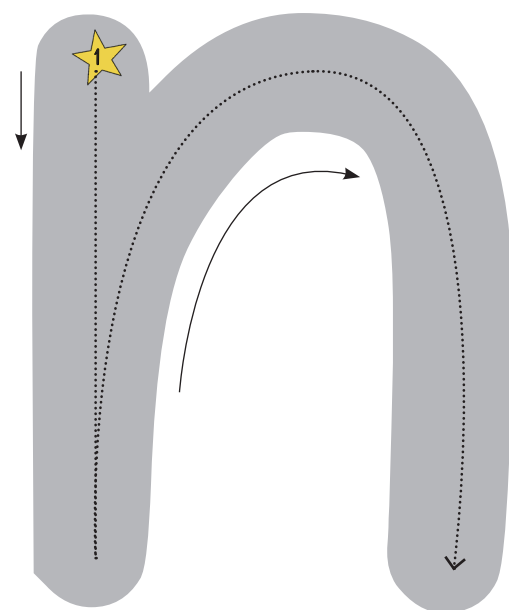
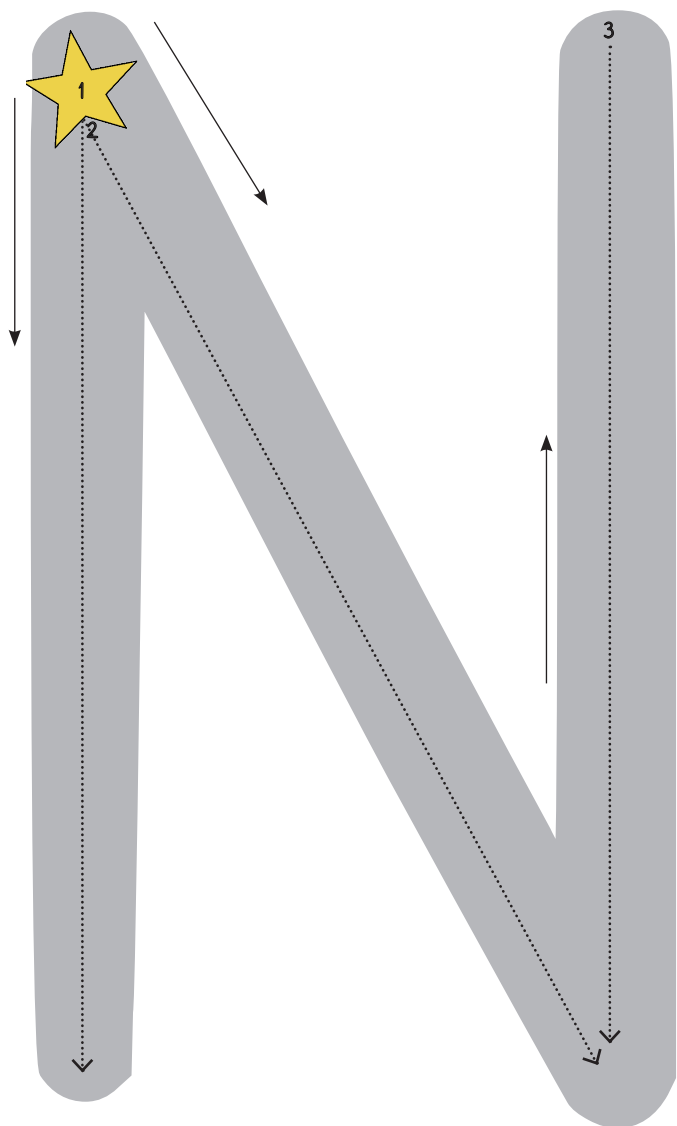

Byg

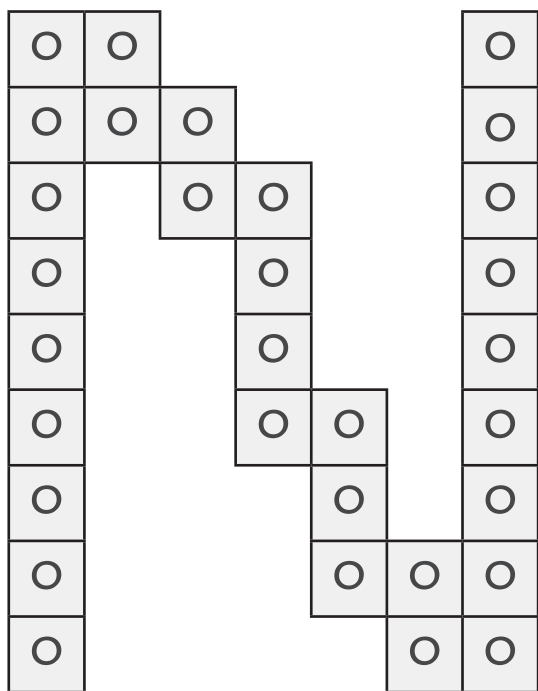

Find



9

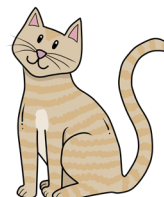
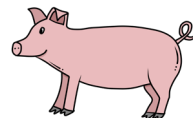
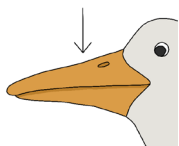
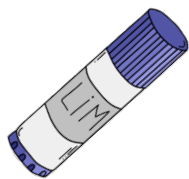

Skriv

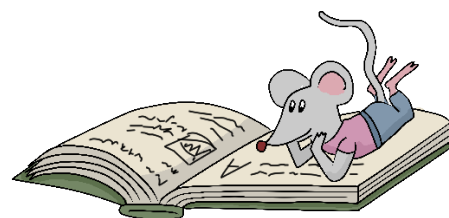
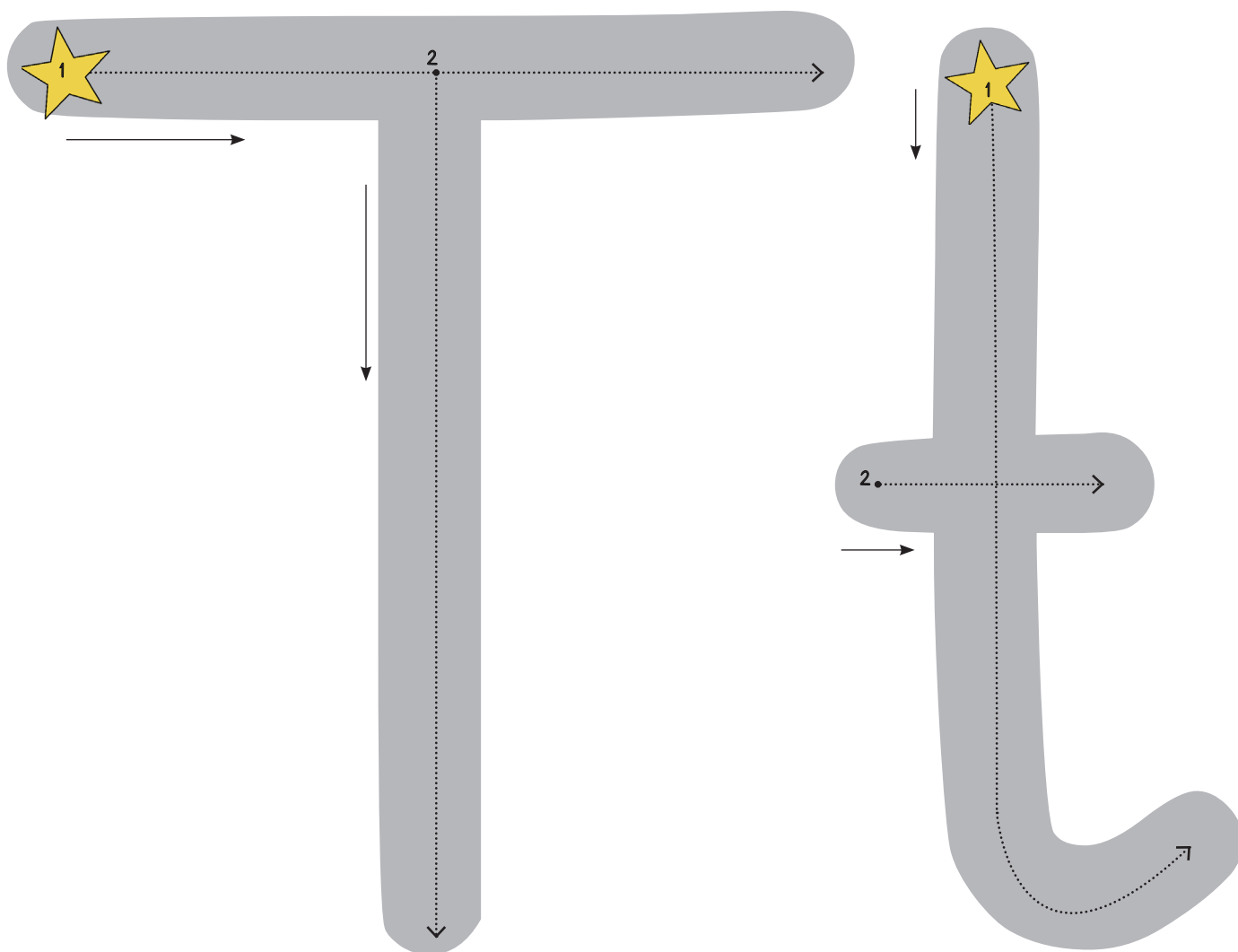

Byg

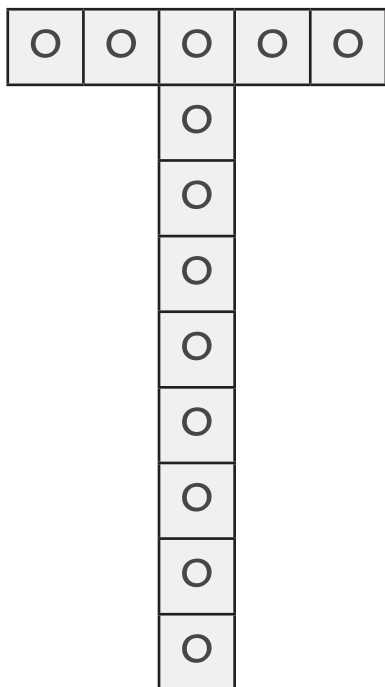

Find

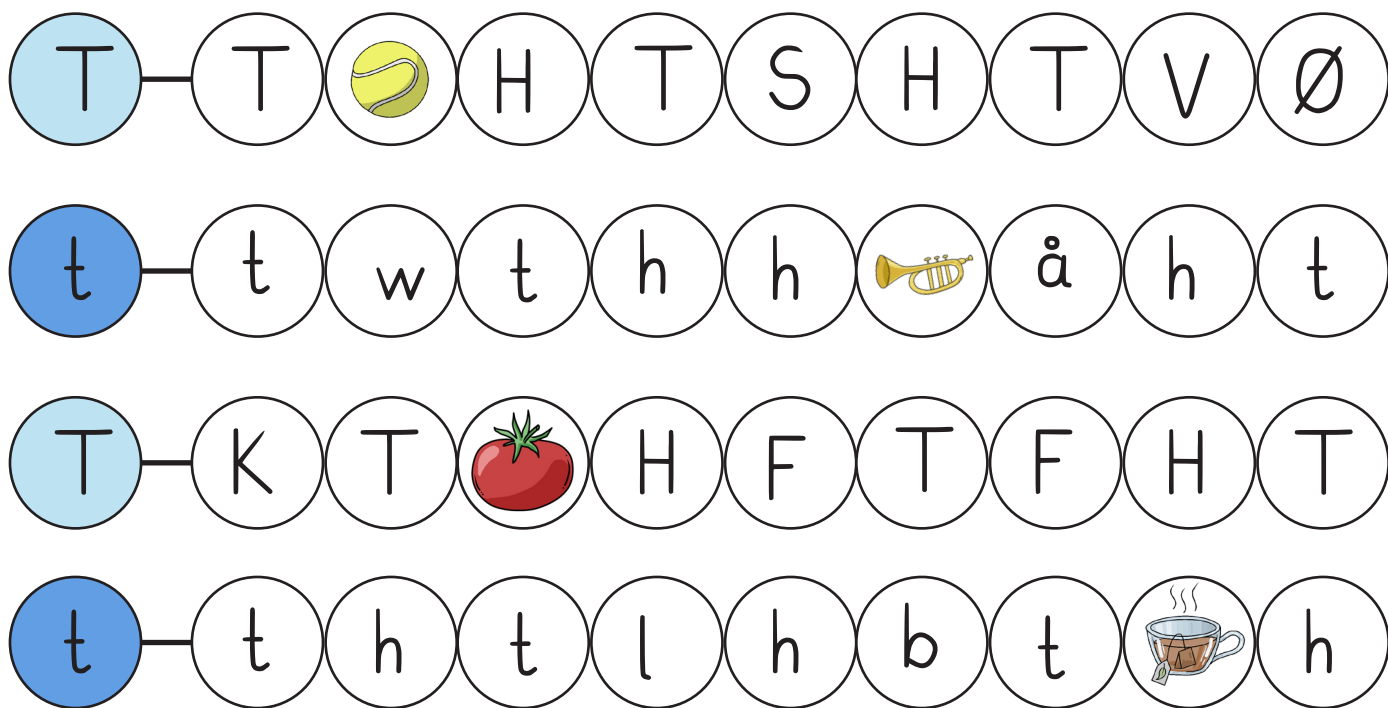

Skriv

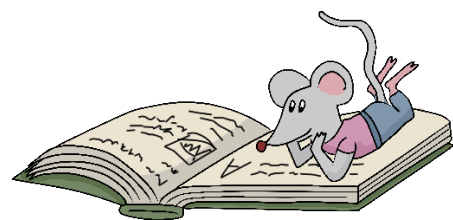
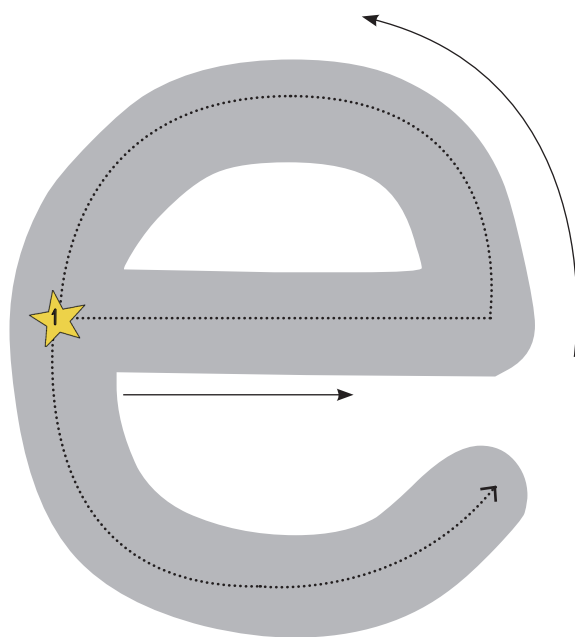
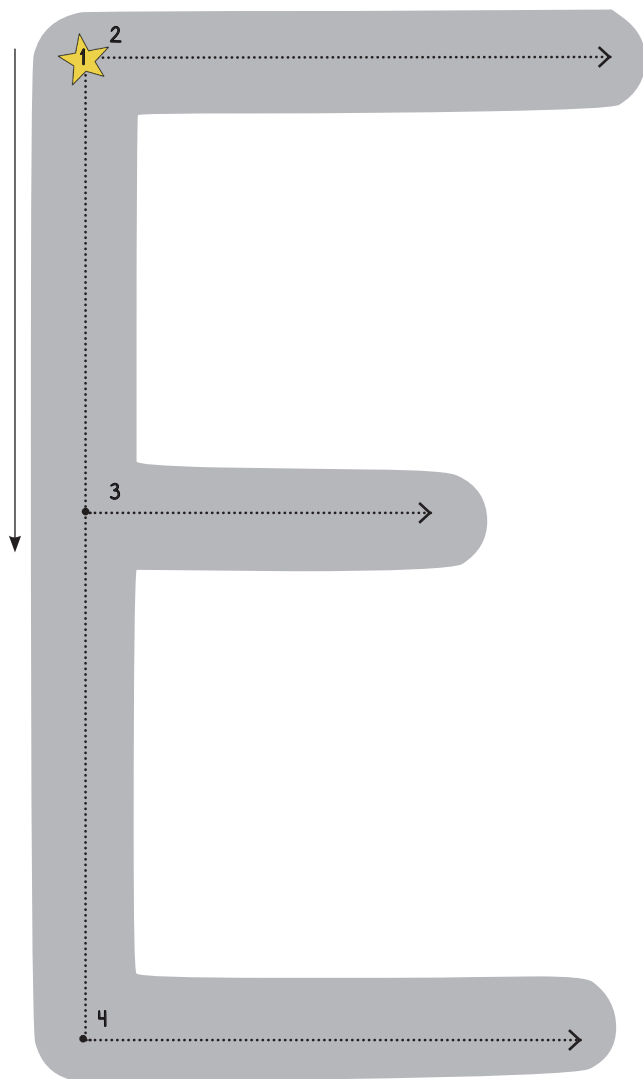

Byg

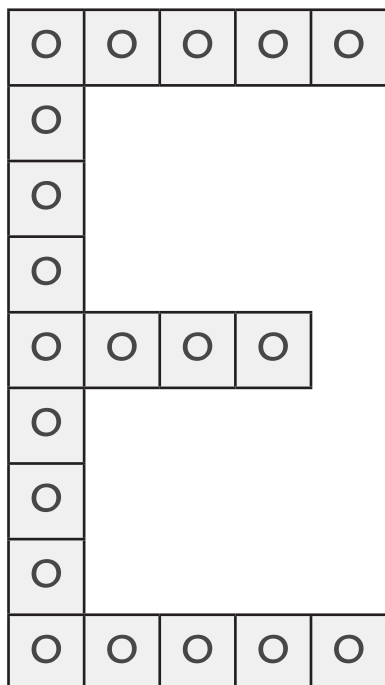

Find



E	e	d	b	G	k	P	e	e	E
v	E	h	c	d	A	a	e	p	v
w	E	e	E	G	m	p	E	e	E
C	v	v	e	a	t	H	W	w	E
e	E	E	e	o	E	E	e	M	e
e	r	w	v	R	e	v	e	E	E
E	e	e	E	E	e	v	j	H	r



Skriv

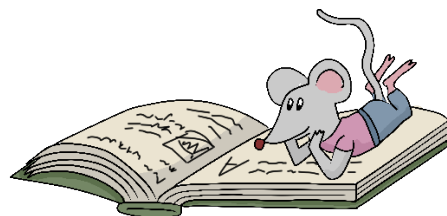
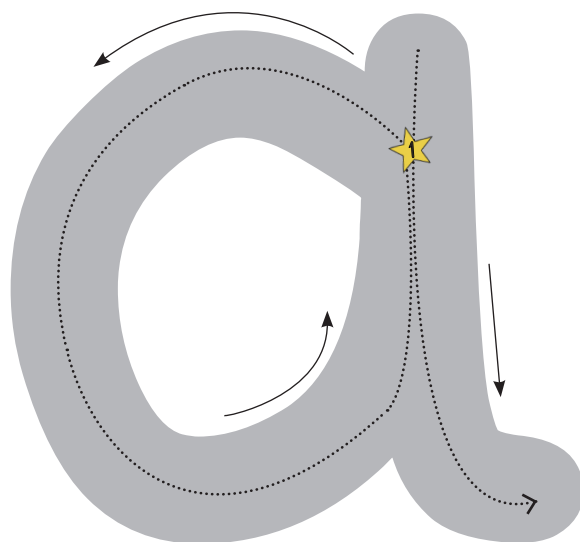
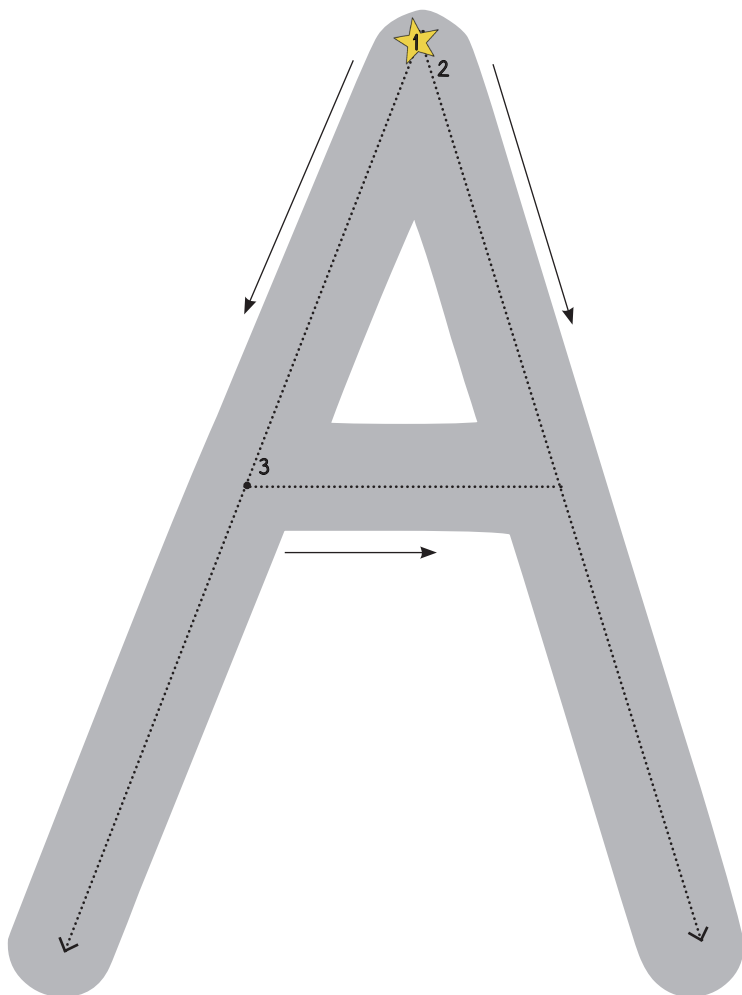

Byg

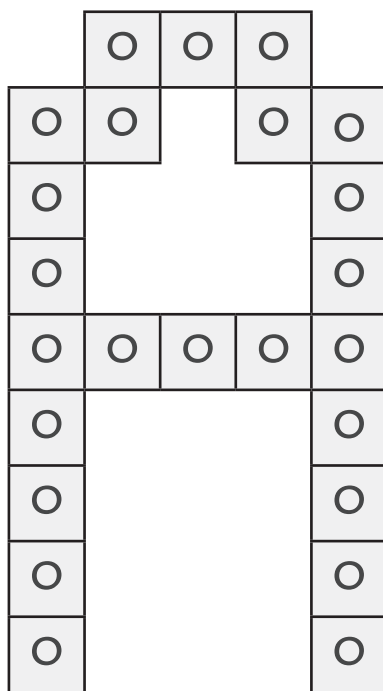

Find

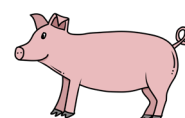
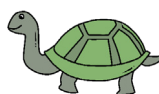
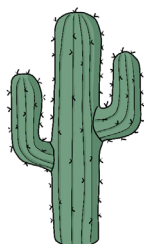
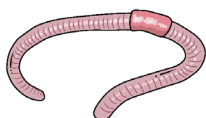

Skriv

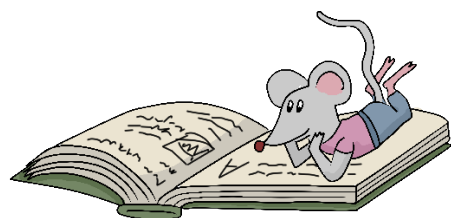
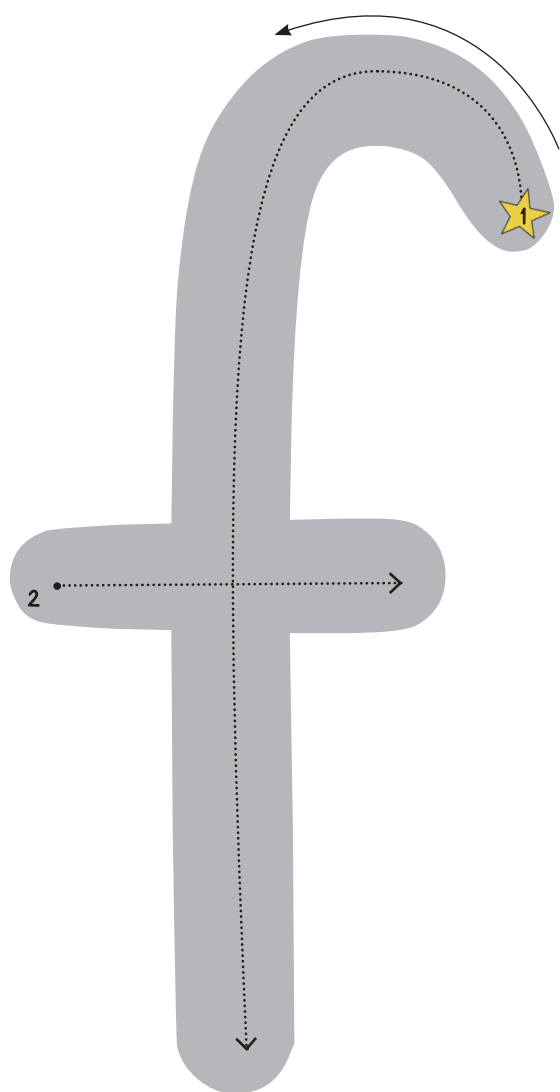
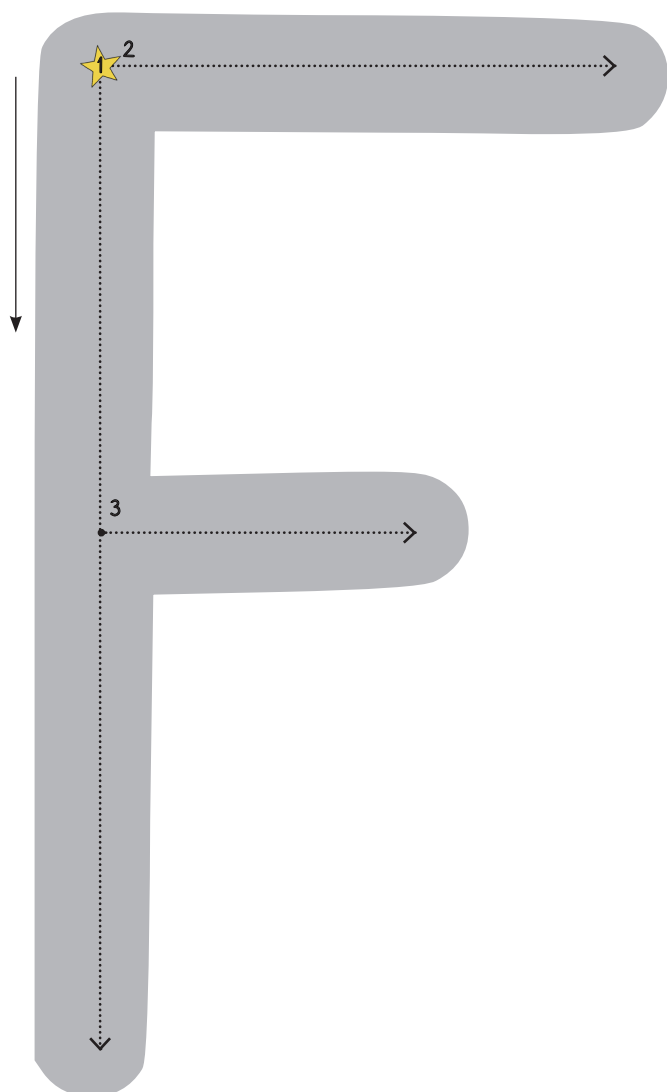

Byg

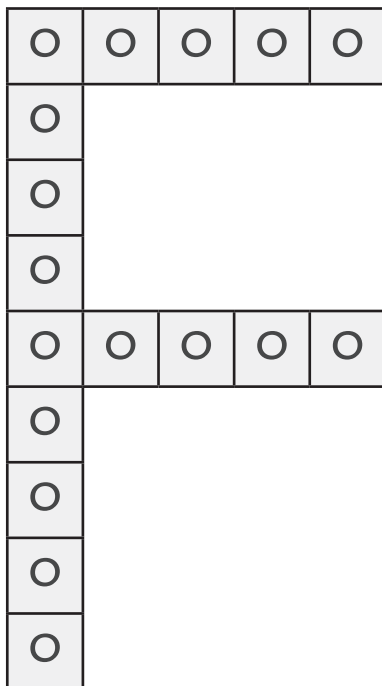

Find

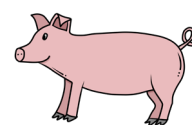
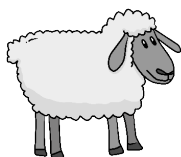
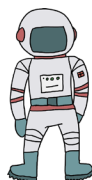
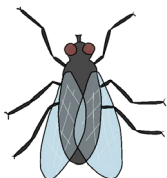

Skriv

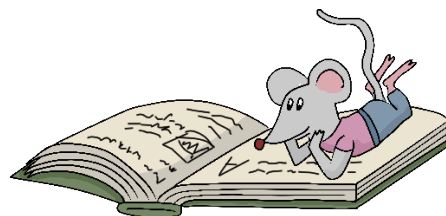
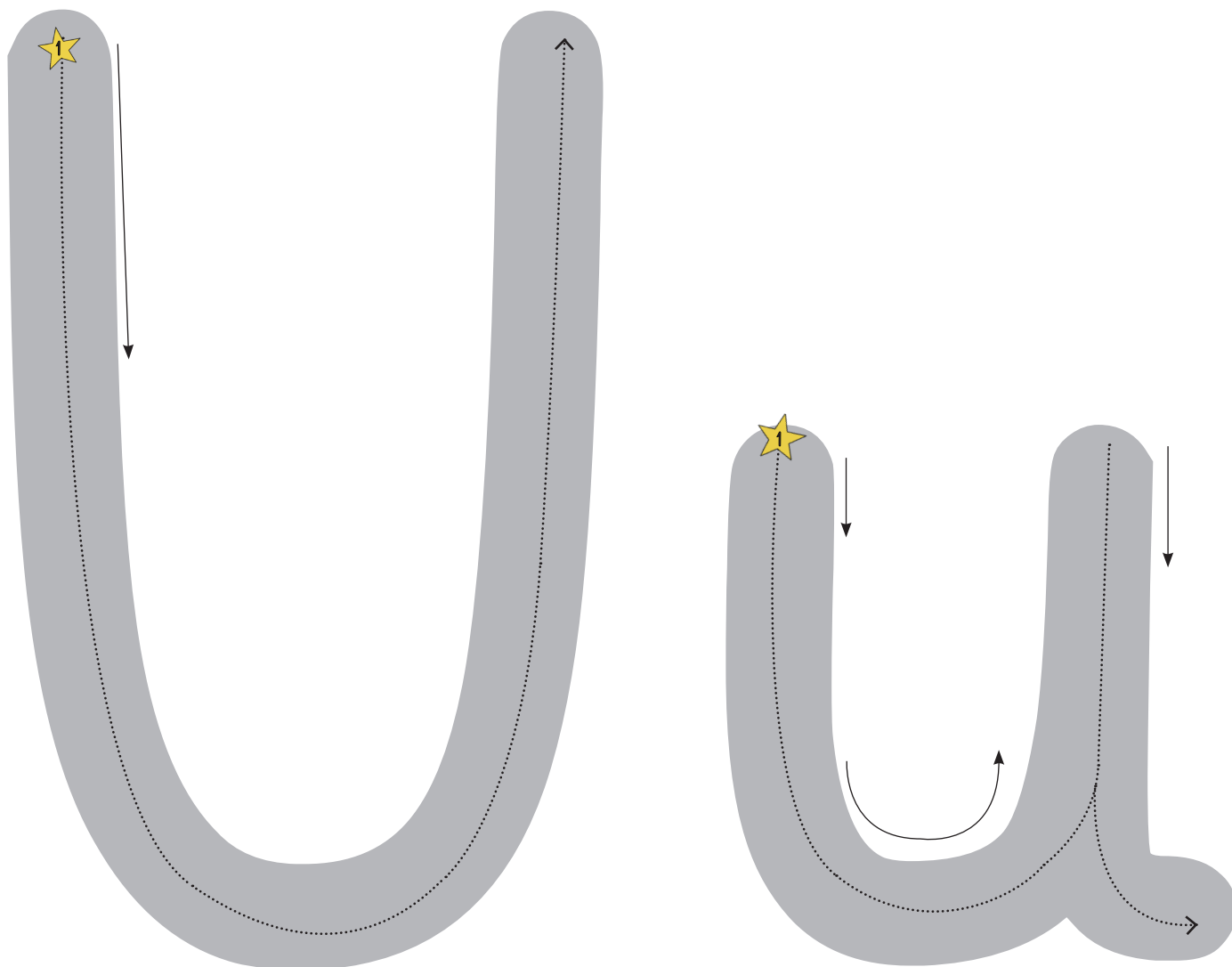

Byg

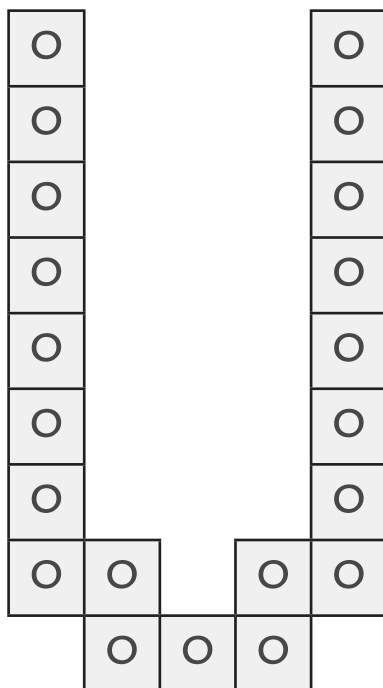

Find

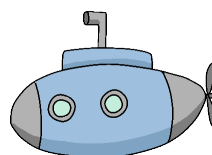
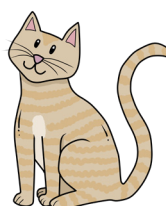
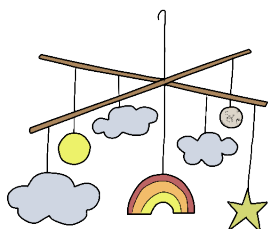
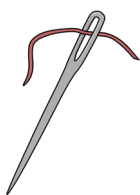
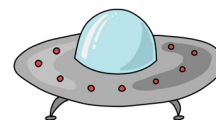
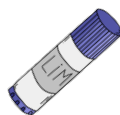
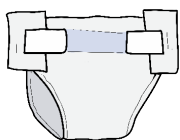
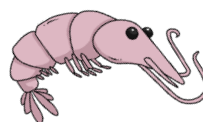
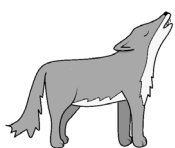

Skriv

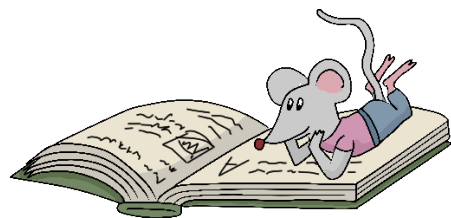
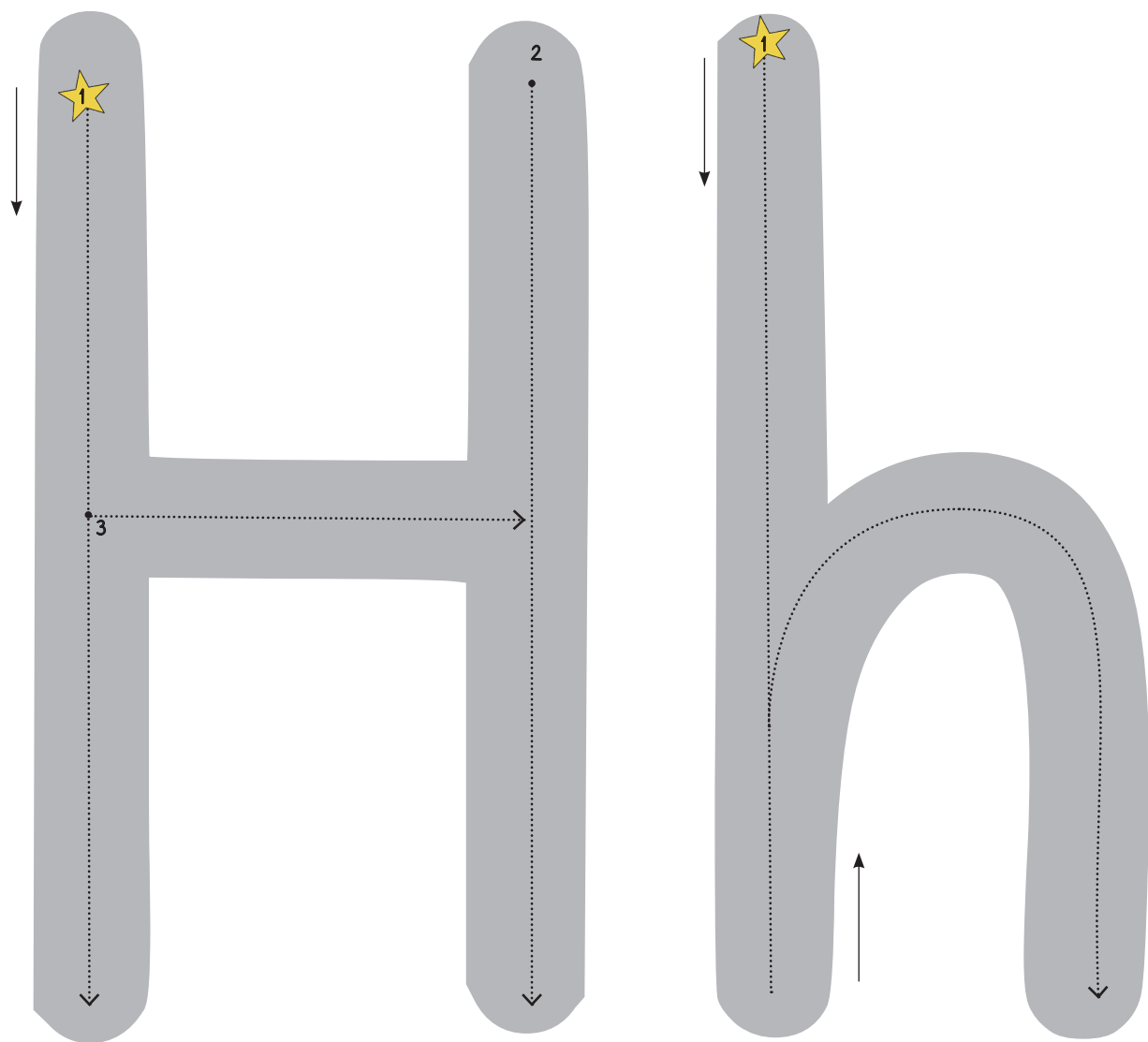

Byg

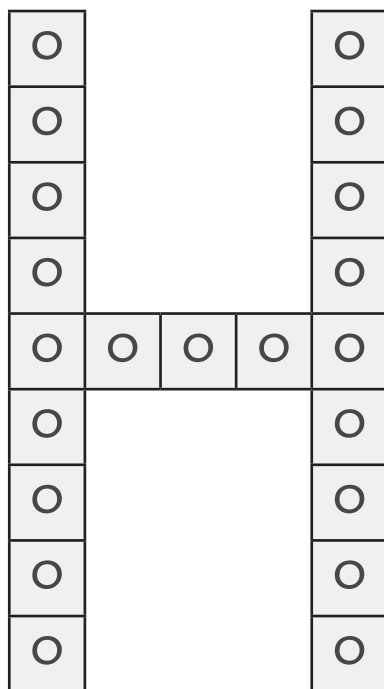

Find

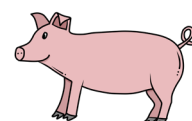
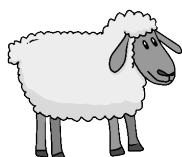
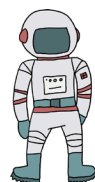
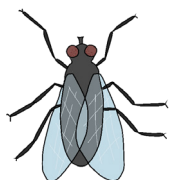

Skriv

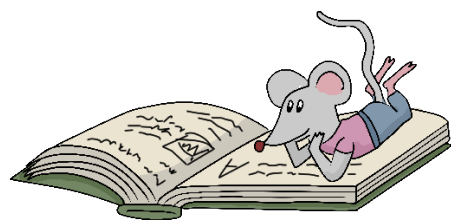
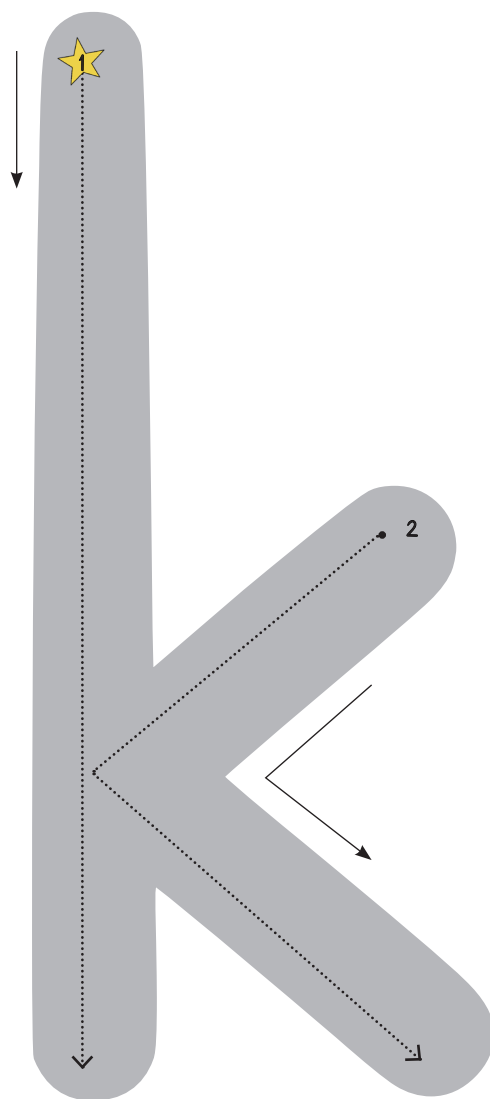
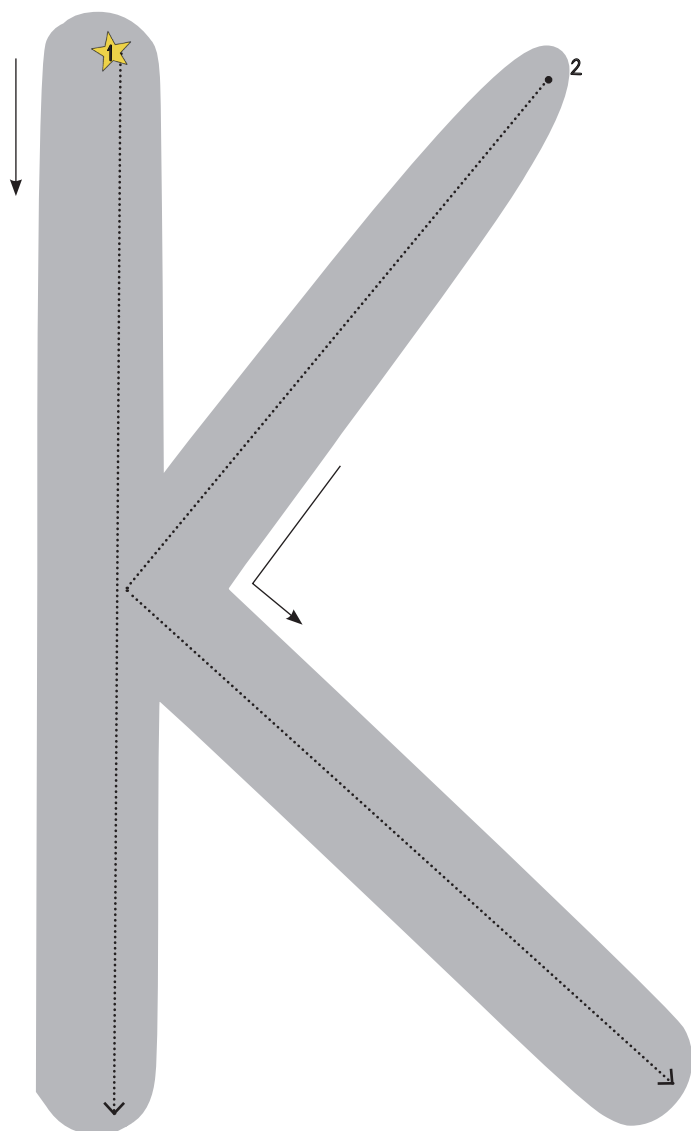

Byg

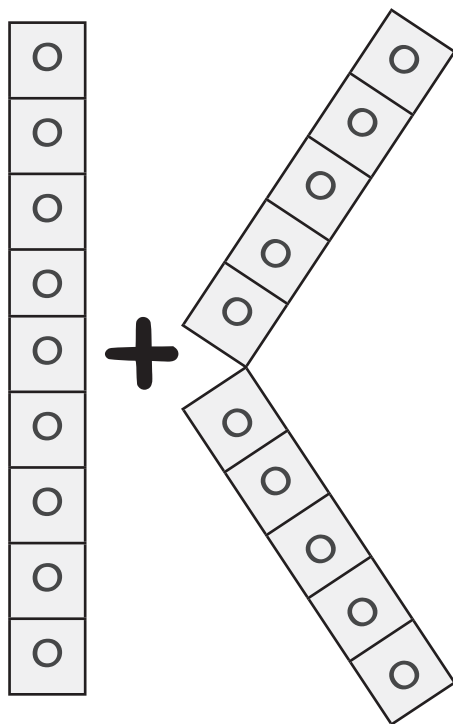

Find

→	K	Ø	d	b	G	k	P	i	l	ø	
	k	b	g	D	d	A	a	Å	p	n	
	k	k	R	k	G	Z	K	k	k	L	
	C	K	k	K	L	t	K	y	K	ø	
	b	R	R	k	o	K	k	n	K	F	
	r	r	B	K	R	k	r	R	K	k	
	r	Æ	j	k	K	k	s	U	H	k	
	R	R	r	r	n	c	d	D	v	K	→

Skriv

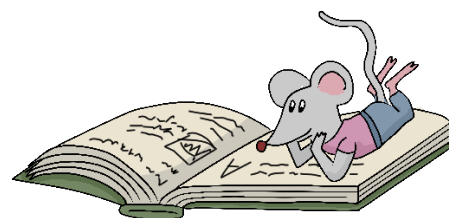
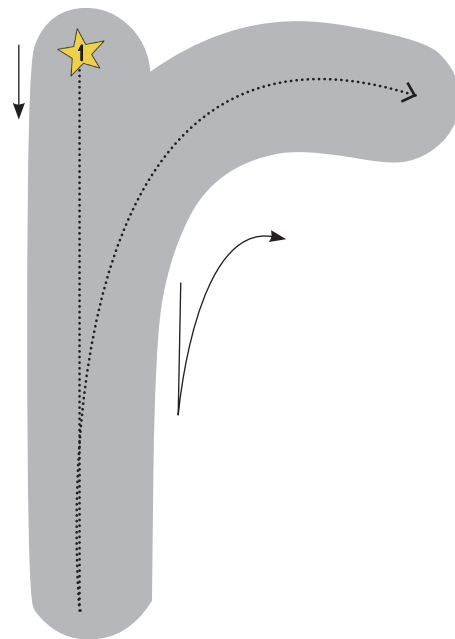
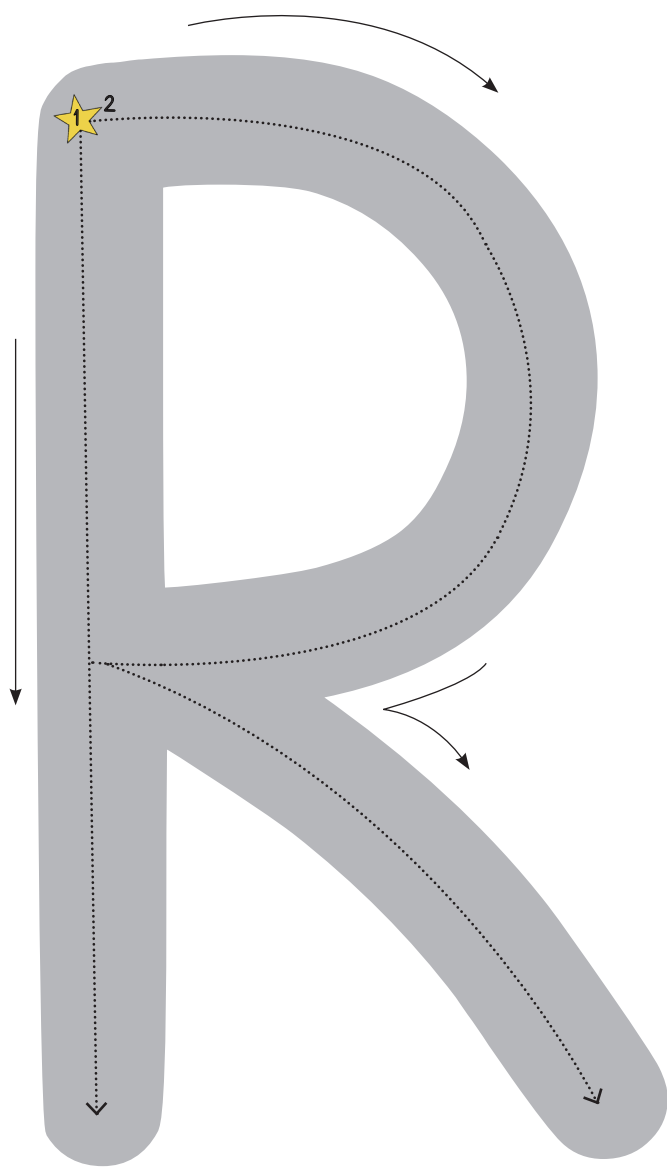

Byg

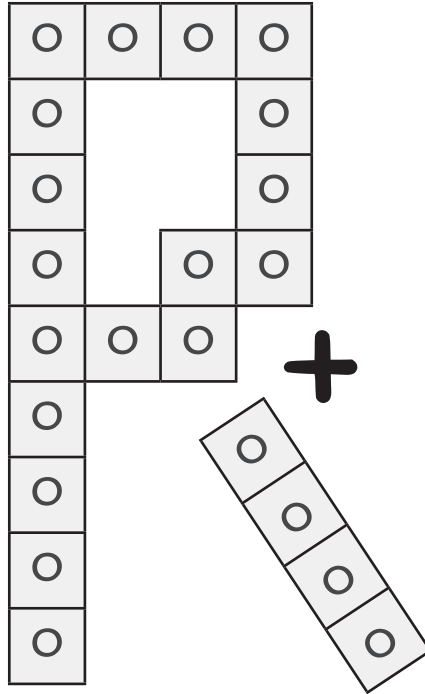

Find

R S R  H R H U R Ø
 r h r q h r s  h r
 R R T  R F M F R T
 r h r b h r b  b h

Skriv

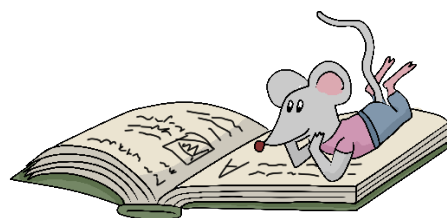
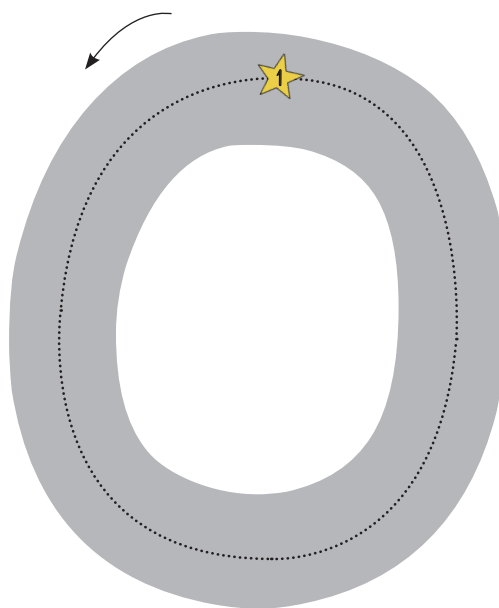
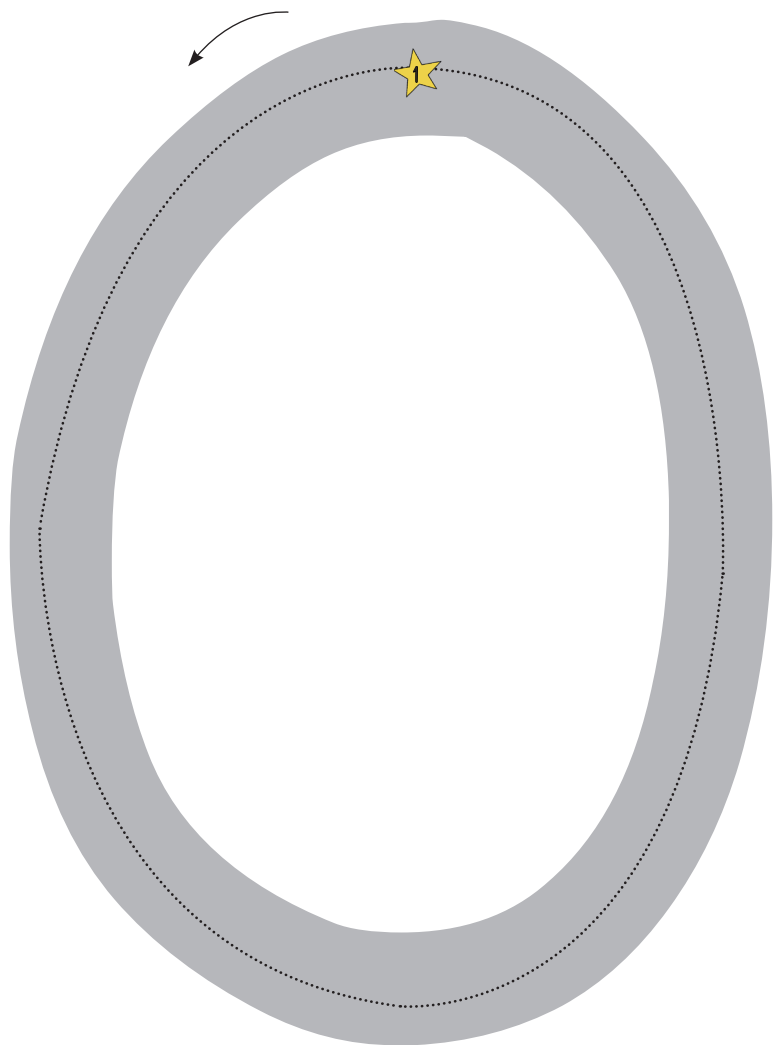

Byg

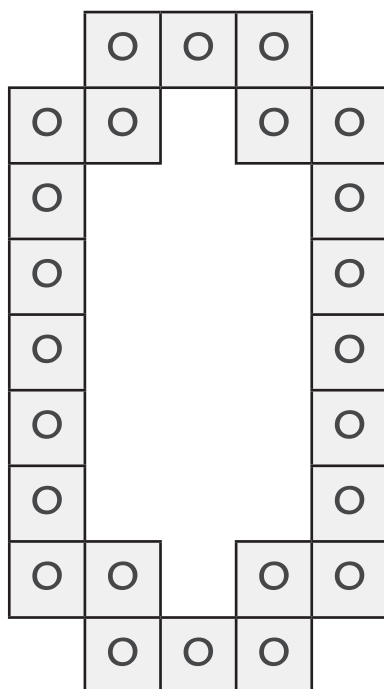

Find

Ä	Y	y	y	s	O	S	o	o	O	o
I	Y	S	y	Y	o	O	O	y	Y	O
a	y	Ä	ä	m	a	ä	y	I	M	o
s	y	Y	o	o	O	Y	o	o	O	O
A	M	y	O	Y	O	O	o	ä	y	Ä

Skriv

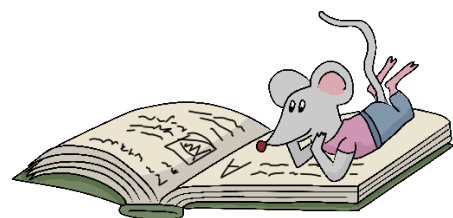
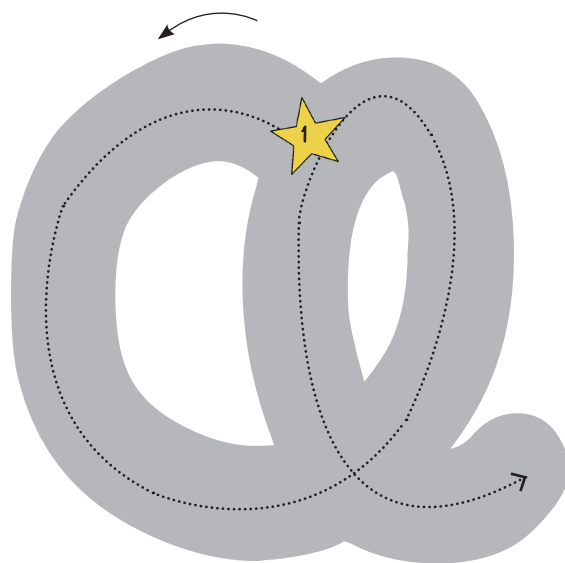
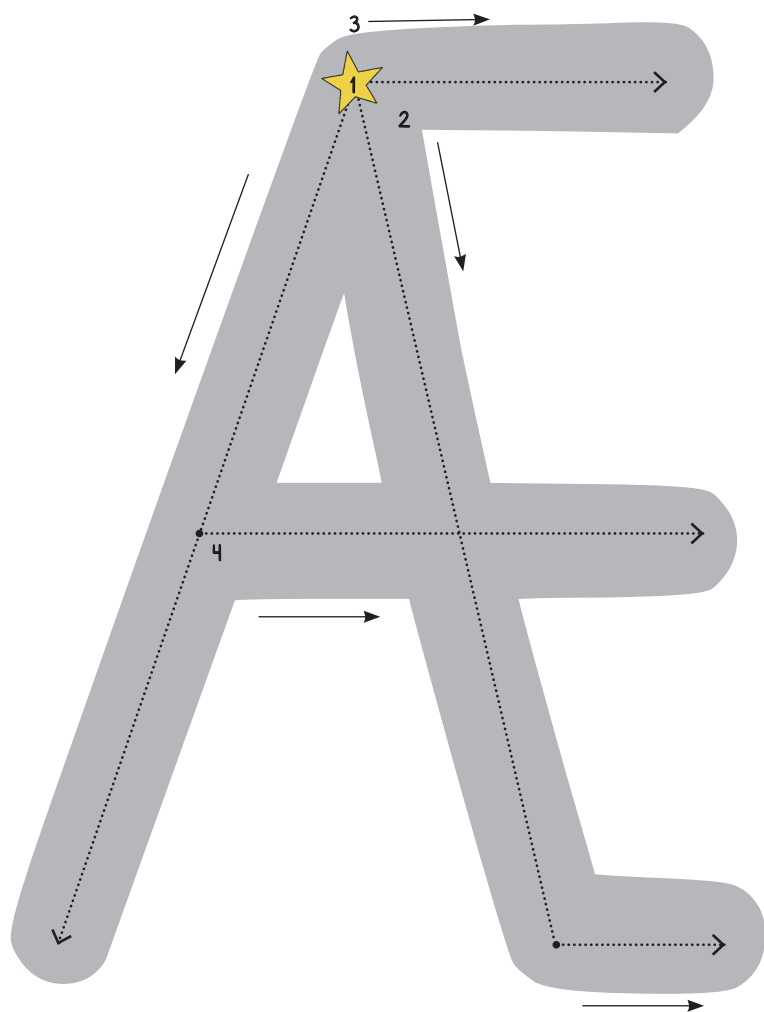

Byg

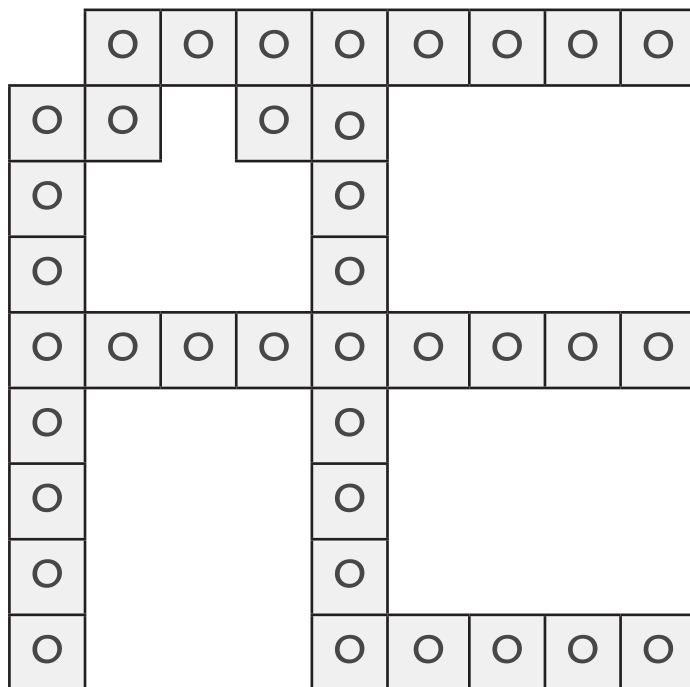

Find

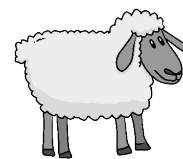
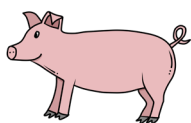
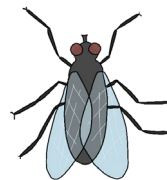

Skriv

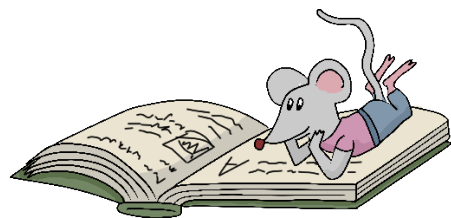
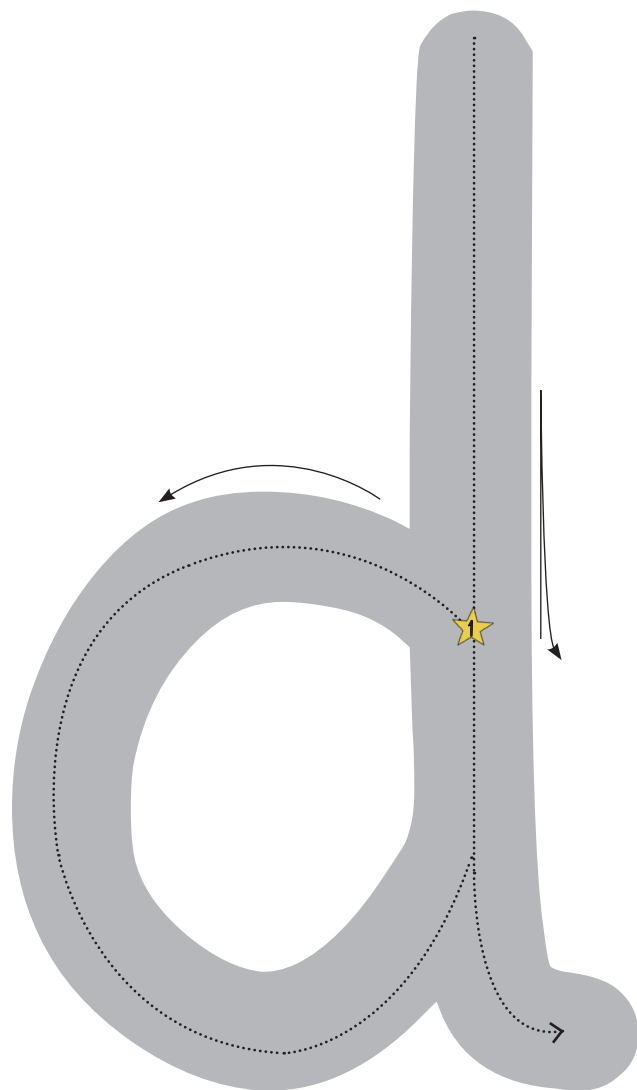
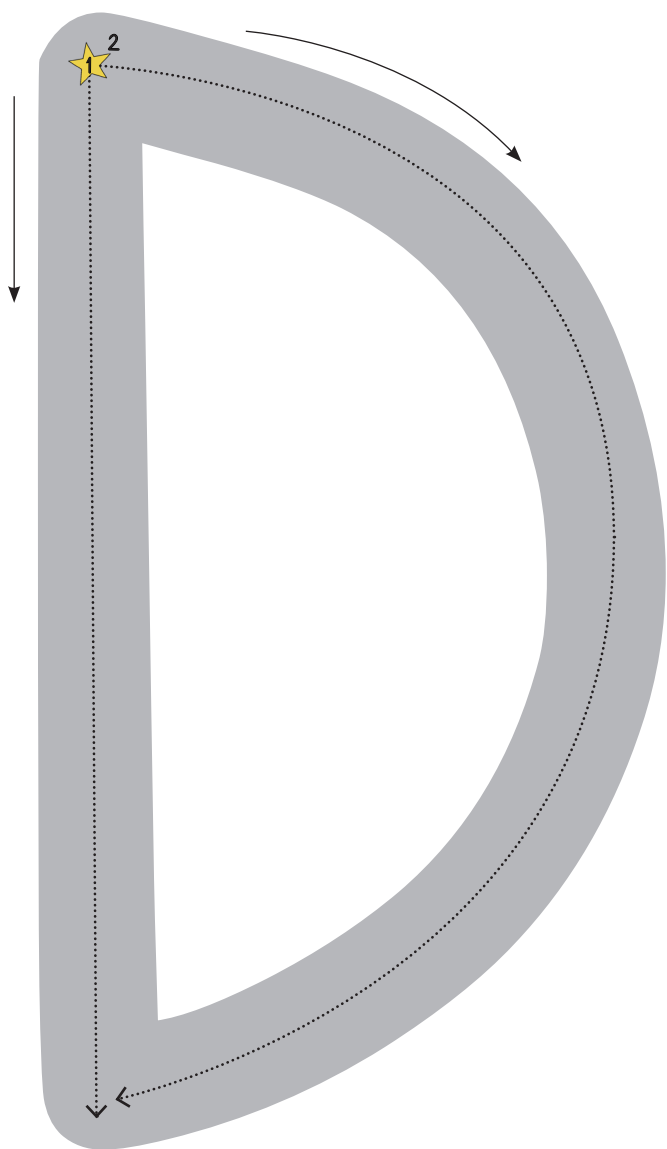

Byg

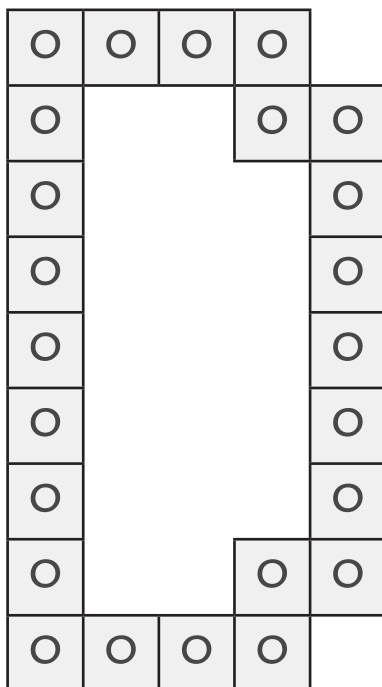

Find

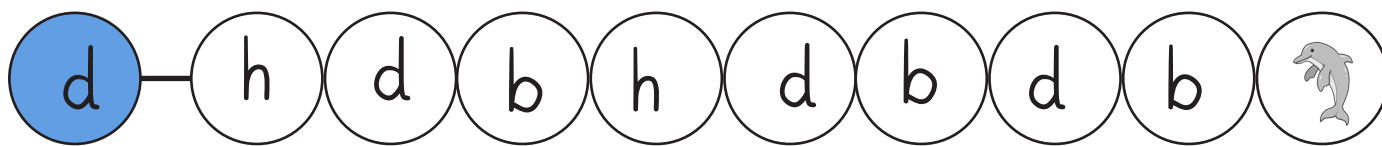
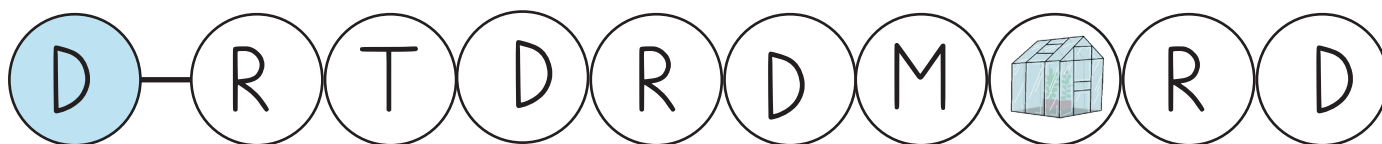
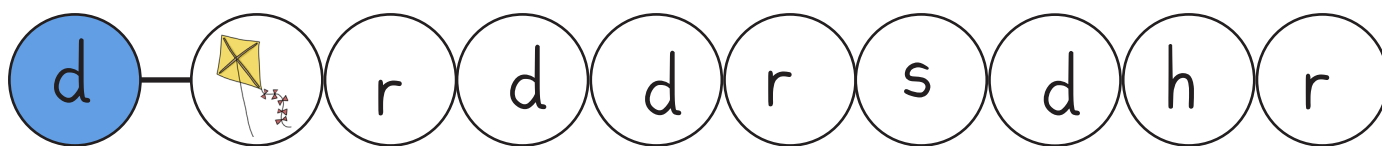

Skriv

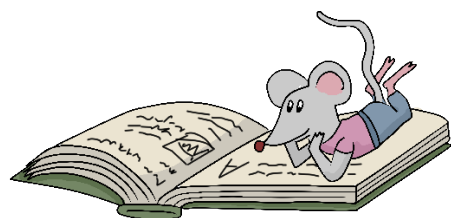
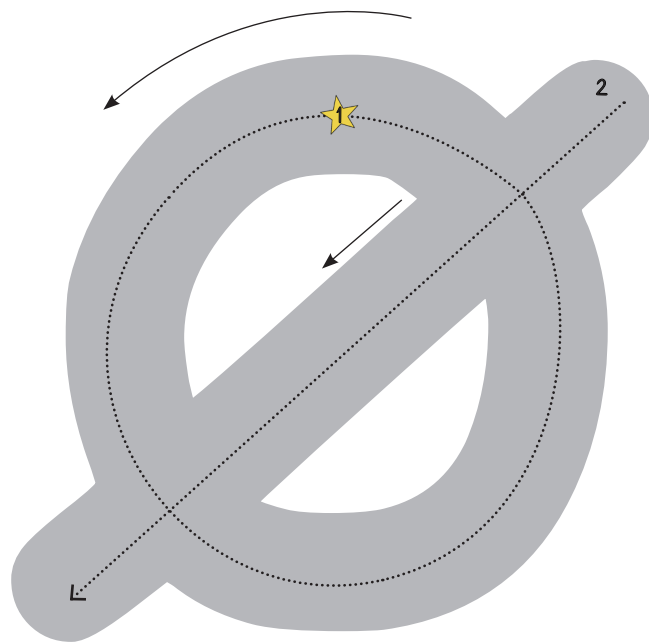
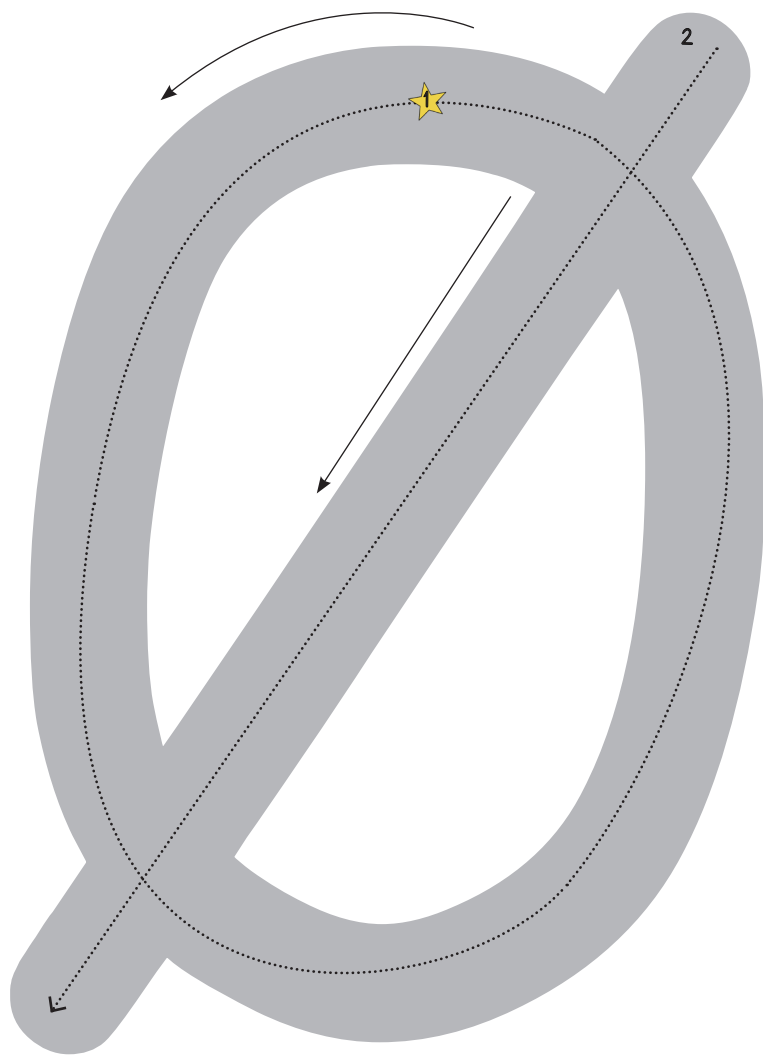

Byg

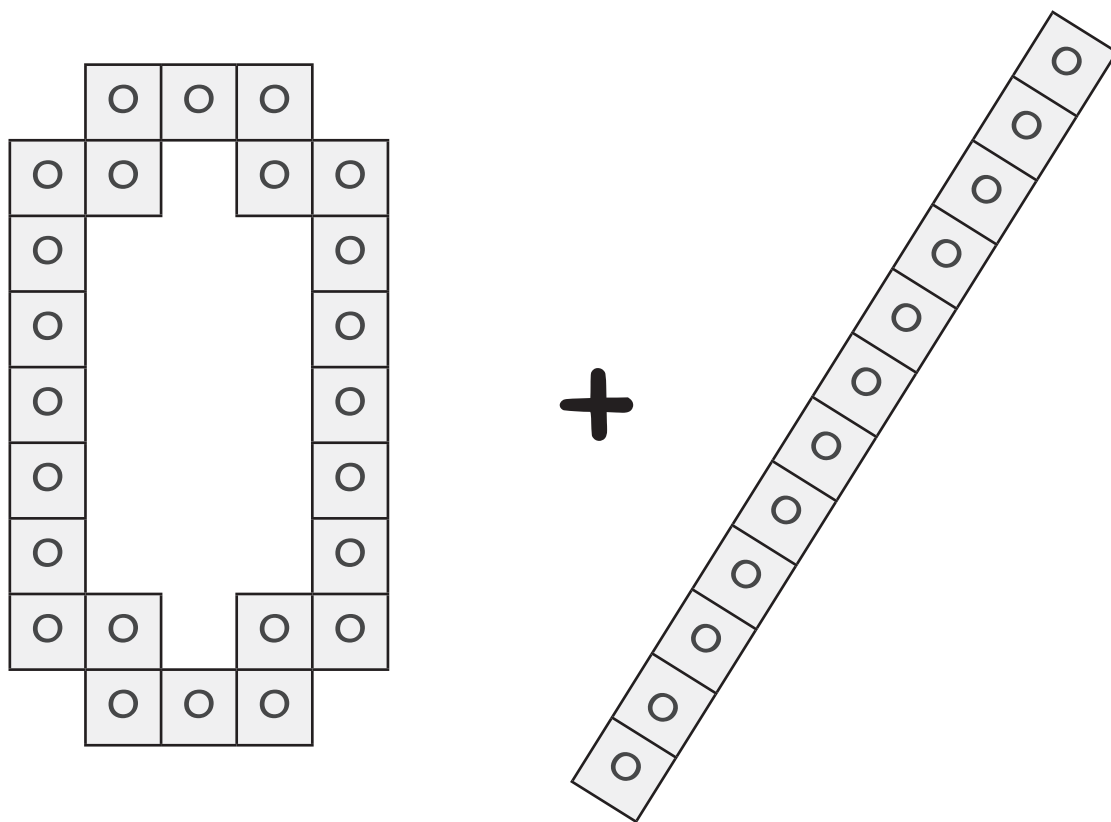

Find

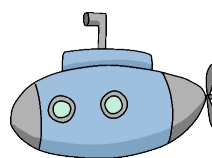
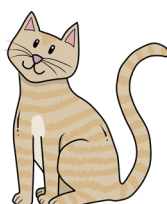
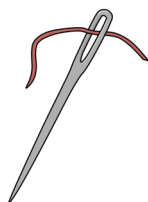
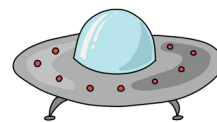
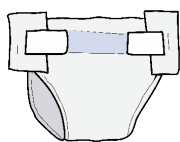
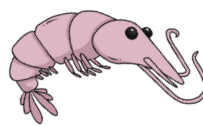

Skriv

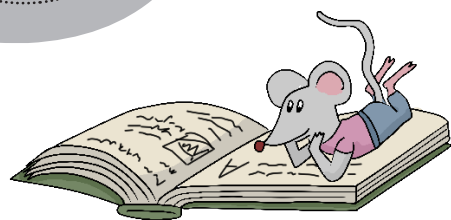
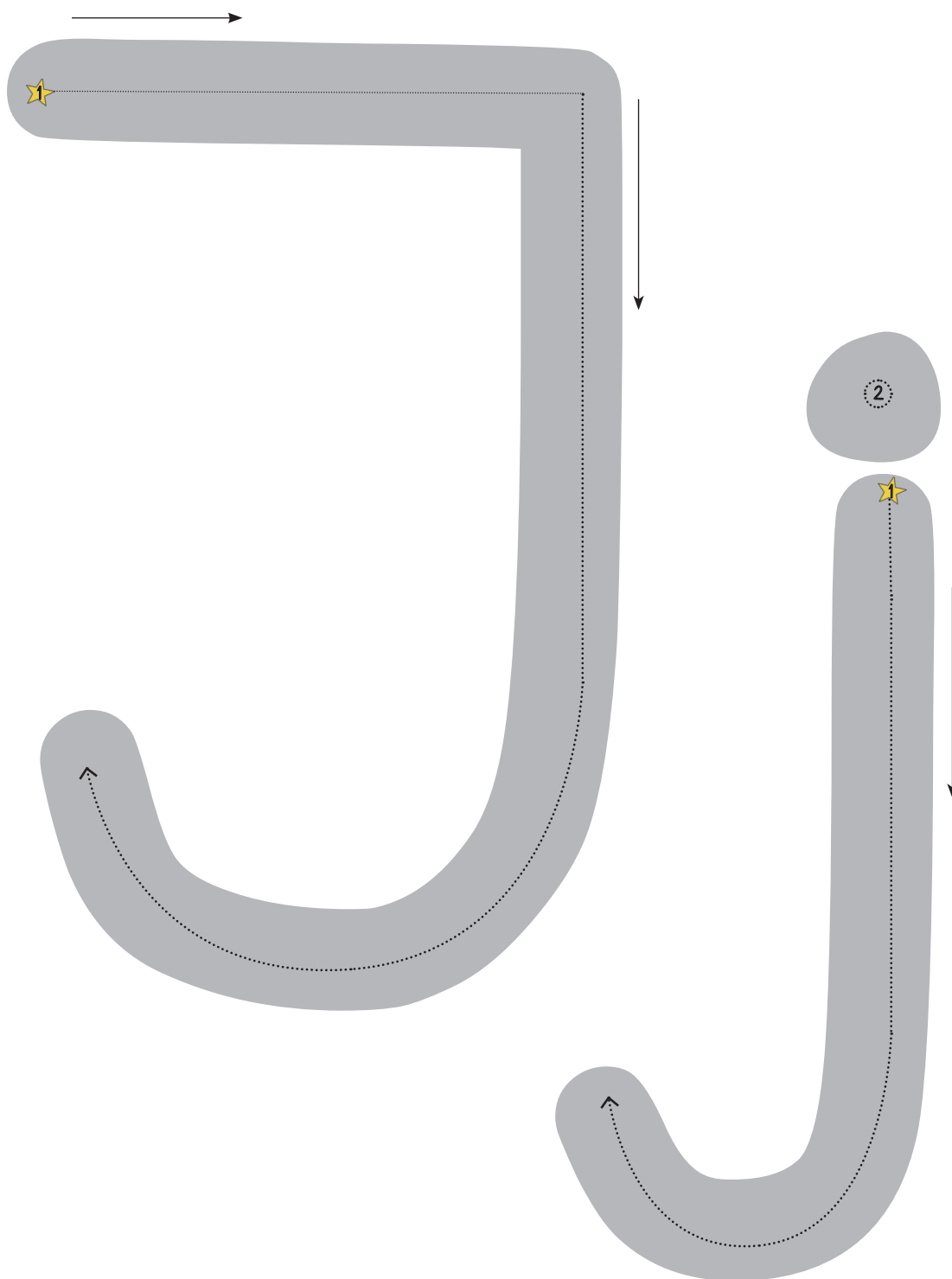

Byg

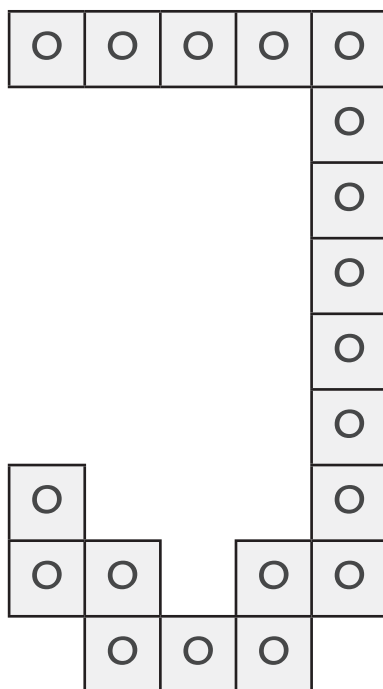

Find



9

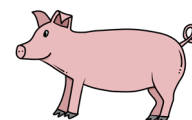
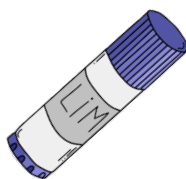

Skriv

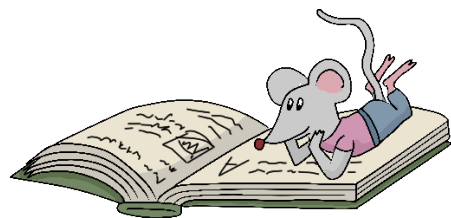
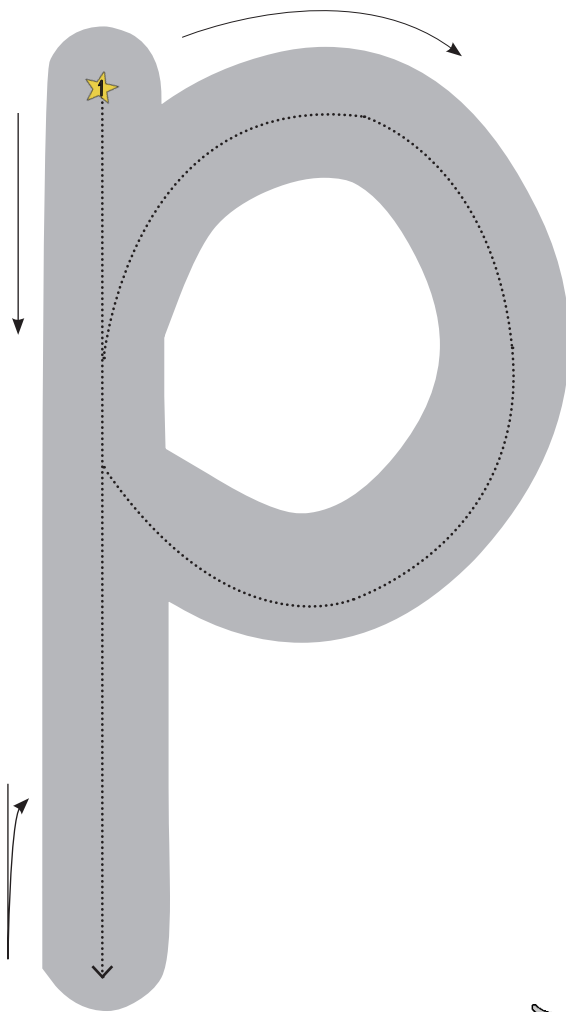
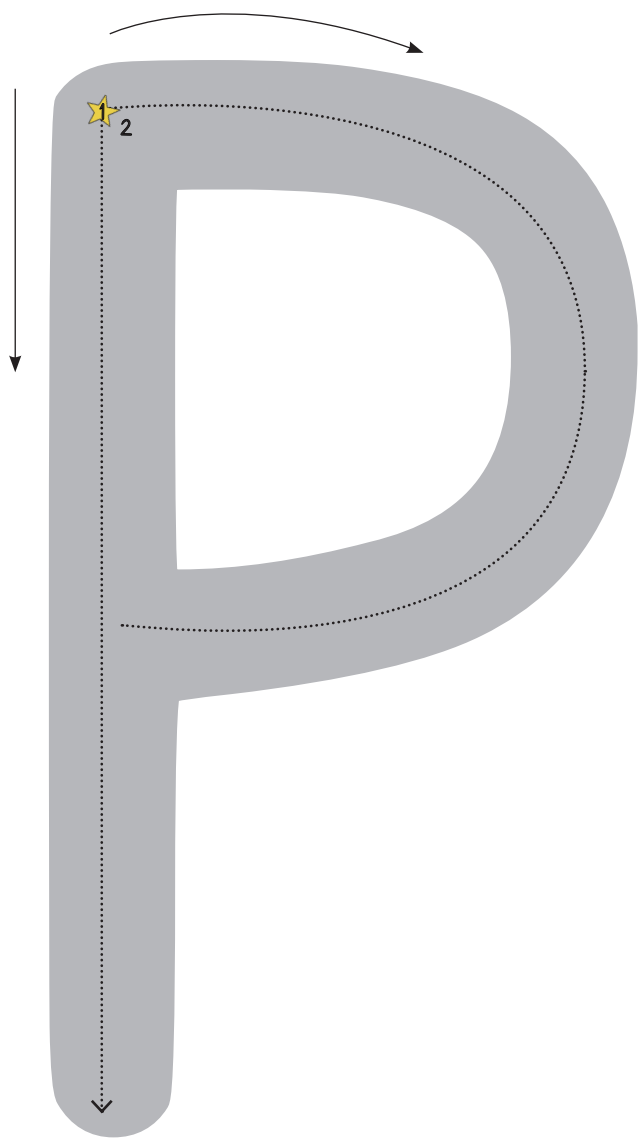

Byg

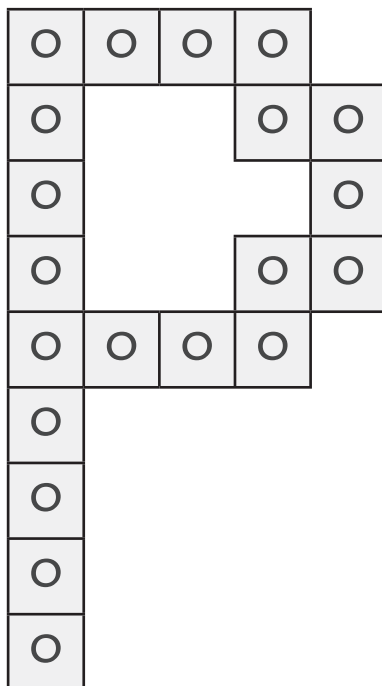

Find

→	P	P	d	b	G	k	b	i	l	ø
	k	p	g	D	d	A	a	Å	b	n
	k	p	R	k	G	Z	K	k	k	L
	p	P	k	K	L	t	K	y	K	p
	P	R	R	p	P	p	k	n	K	P
	P	p	B	P	R	p	r	R	P	p
	r	P	p	p	K	p	p	U	p	k
	R	R	r	r	n	c	P	P	p	b



Skriv

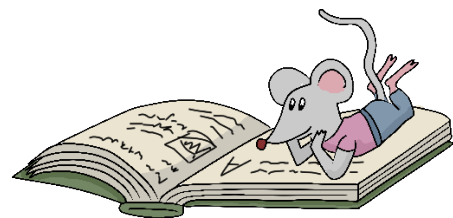
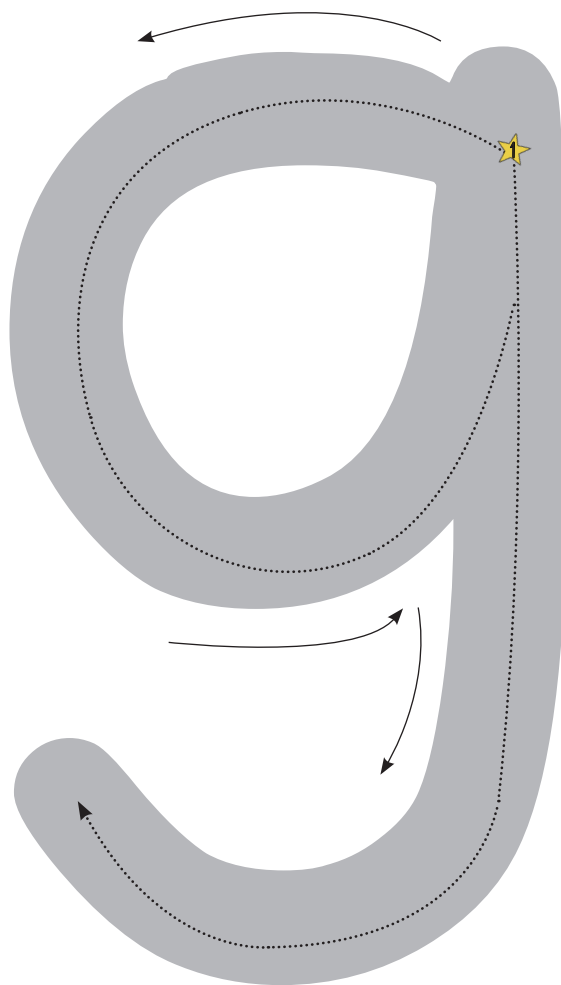
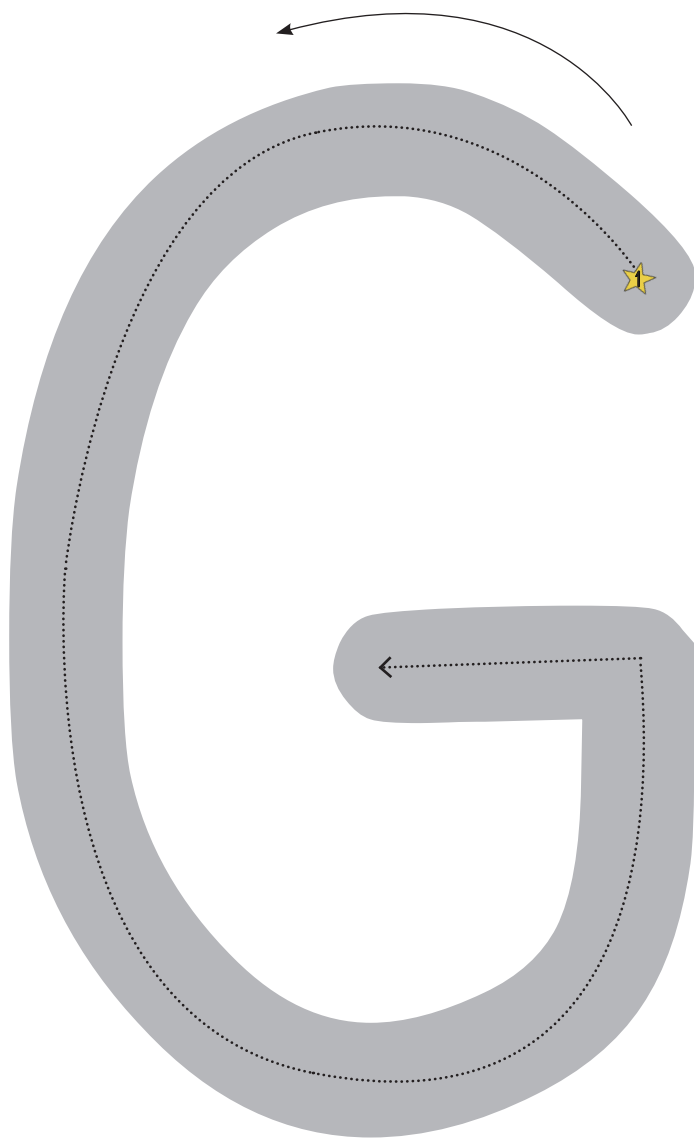

Byg

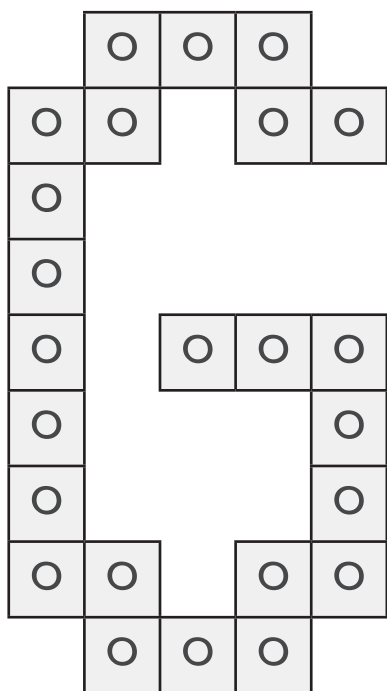

Find

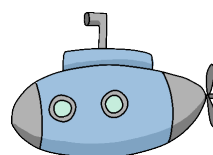
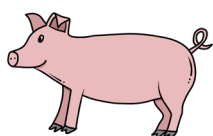
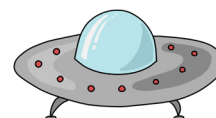
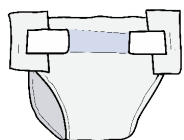
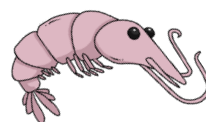
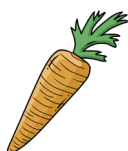

Skriv

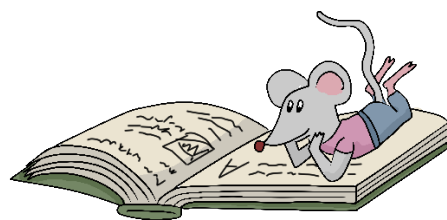
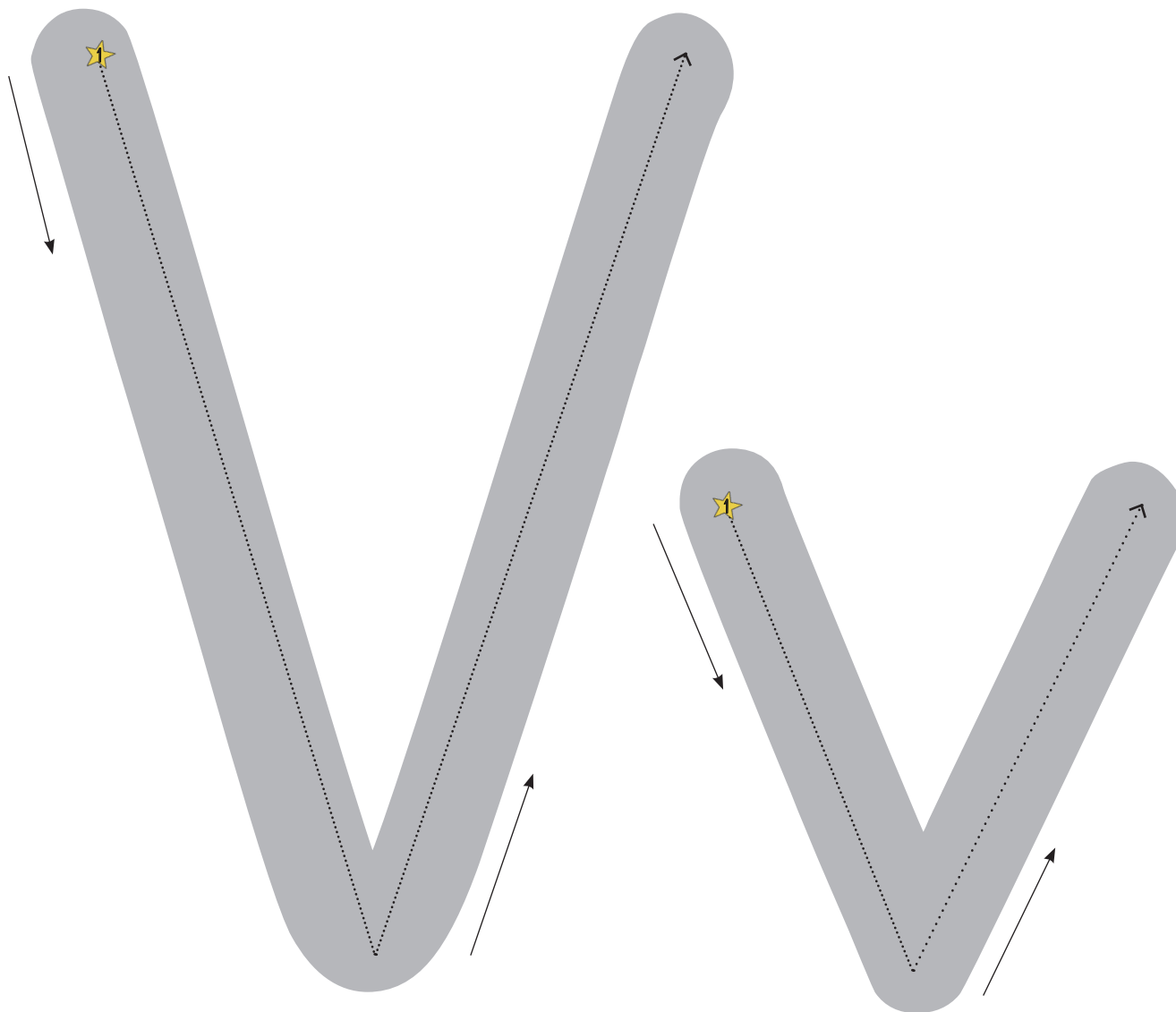

Byg

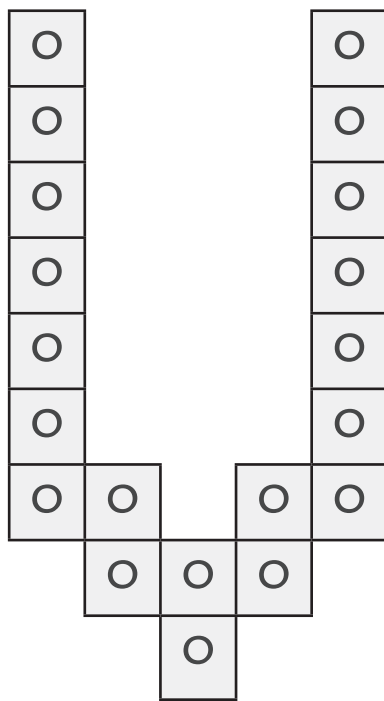

Find

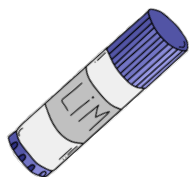
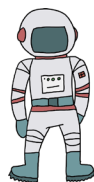
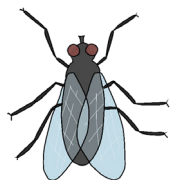
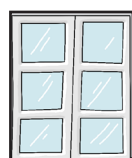

Skriv

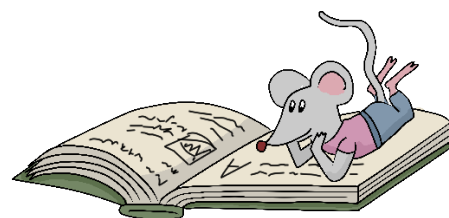
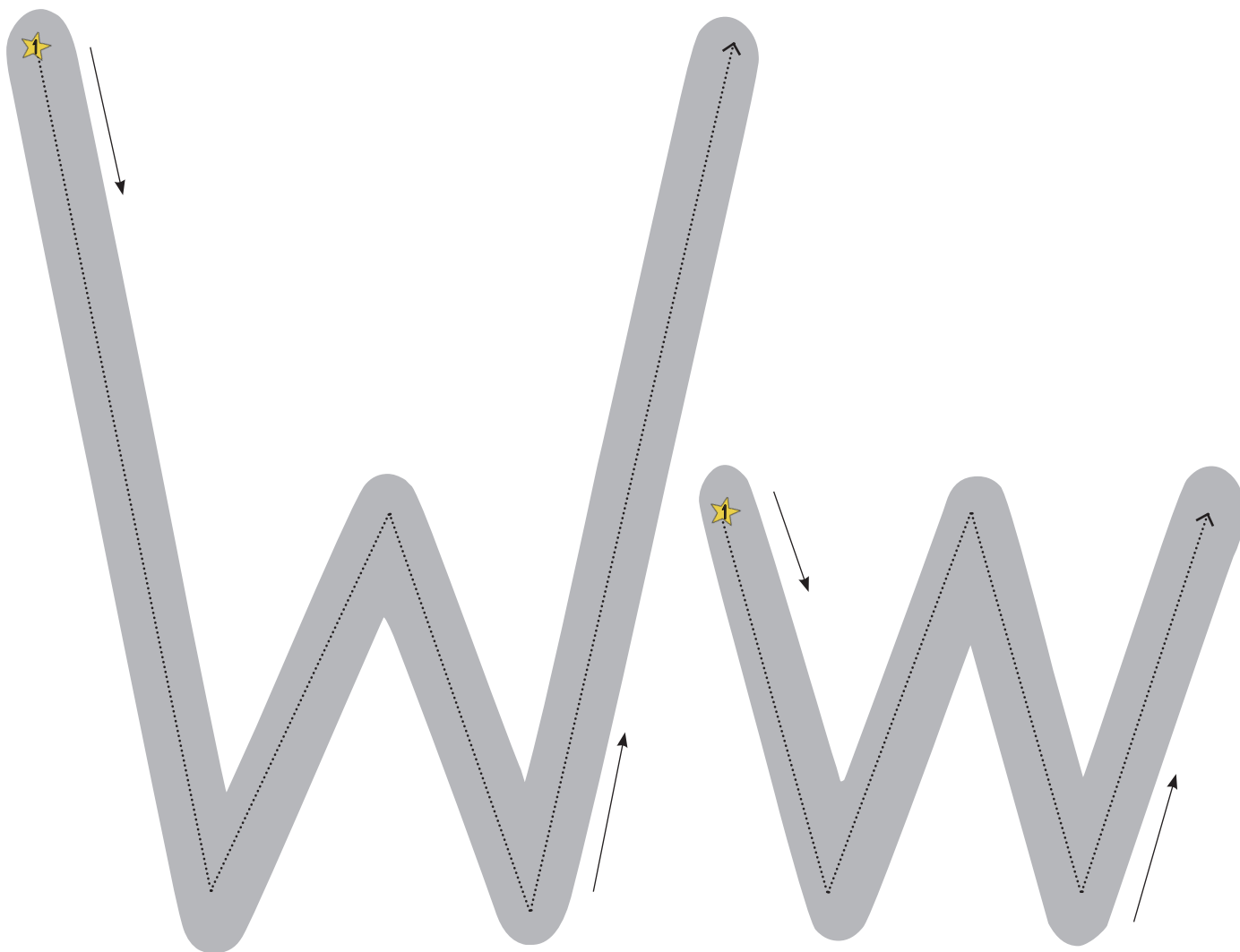

Byg

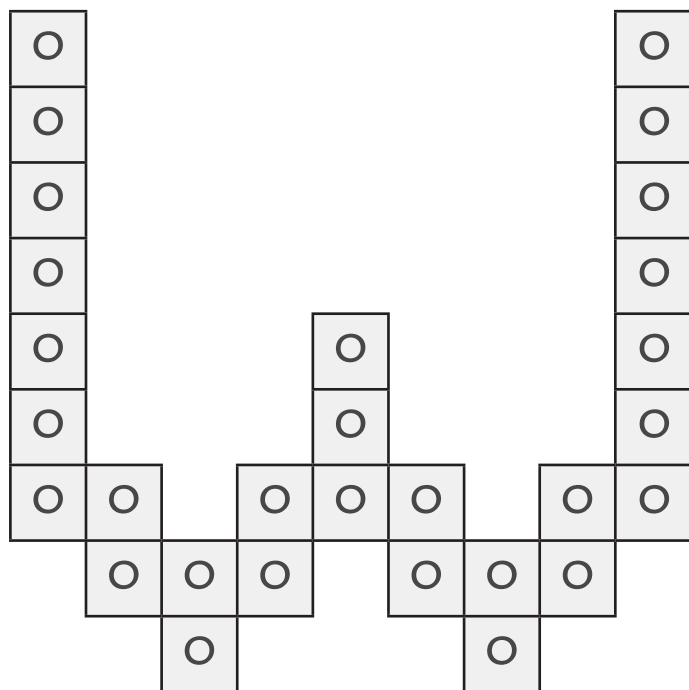

Find

W W W D H W D U U W

w r w d r w d w r

W R W D W D W H W D

w v d v h d v d b v

Skriv

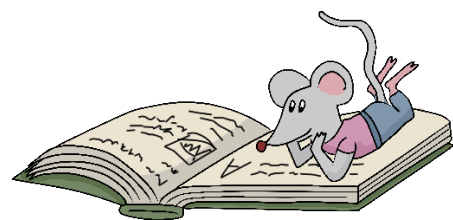
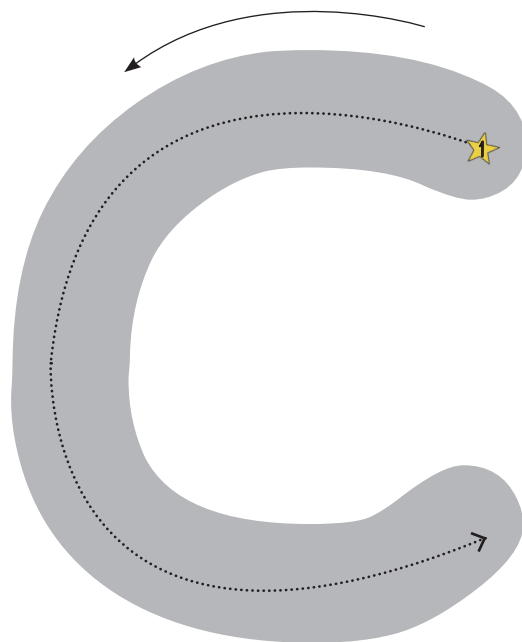
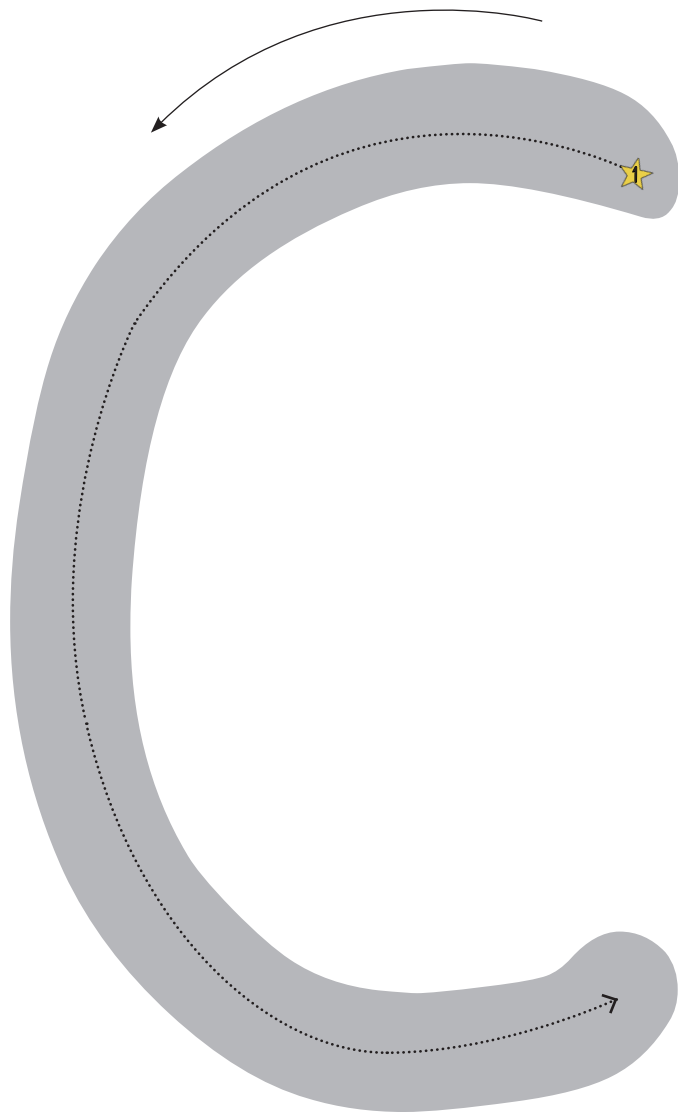

Byg

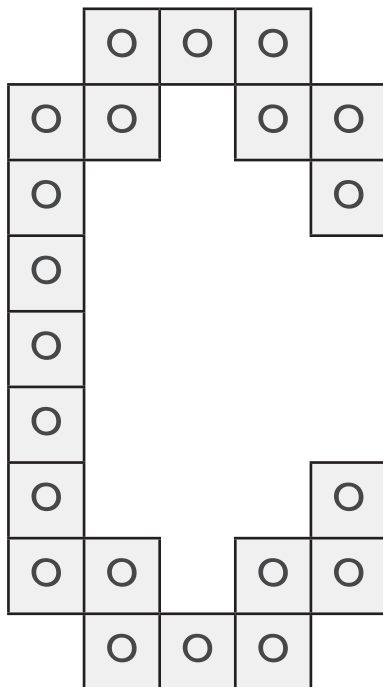

Find

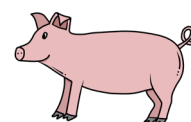
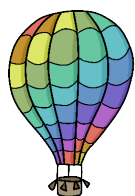
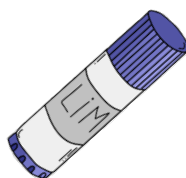

Skriv

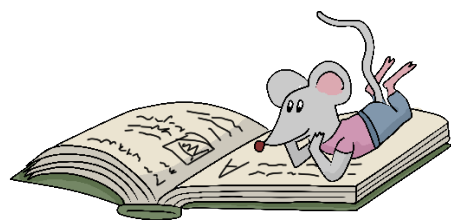
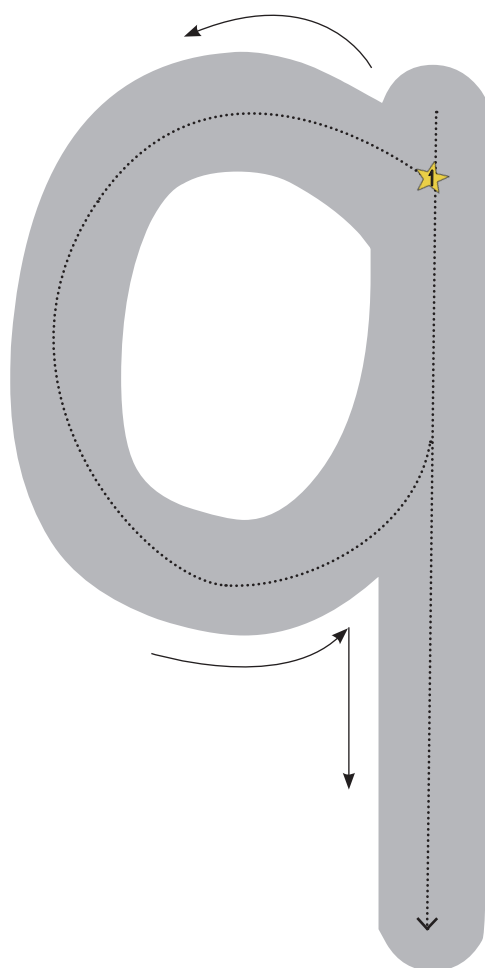
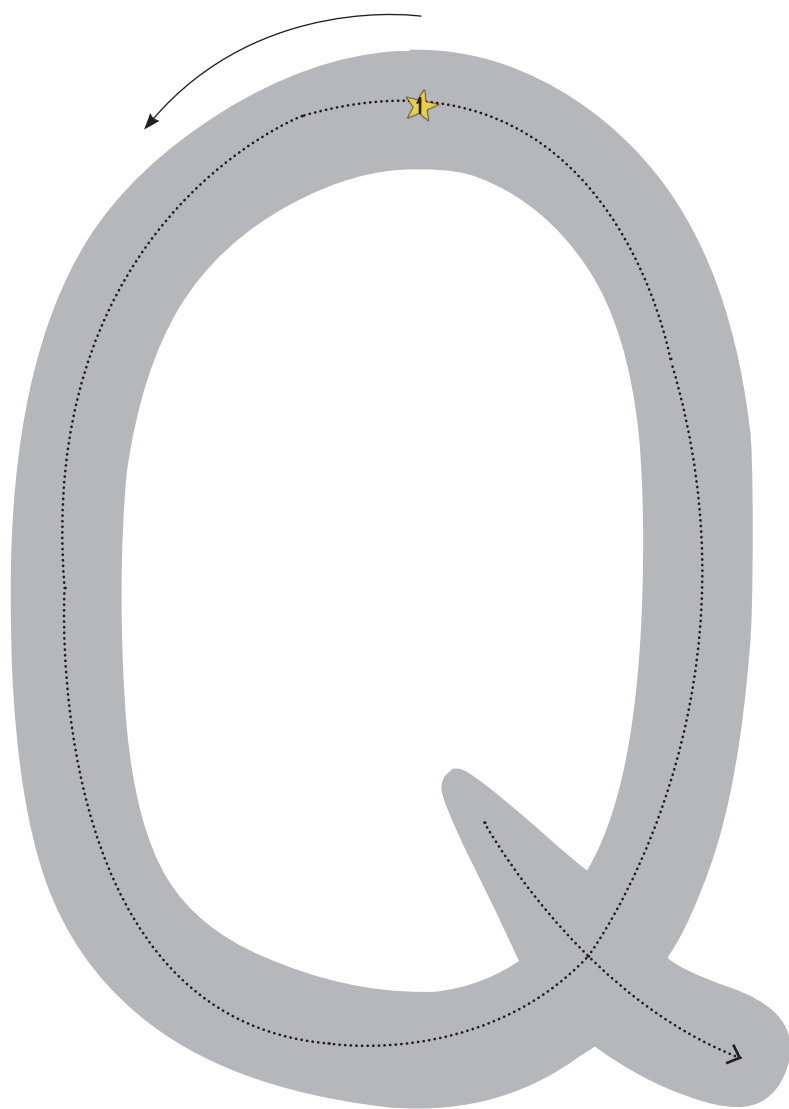

Byg

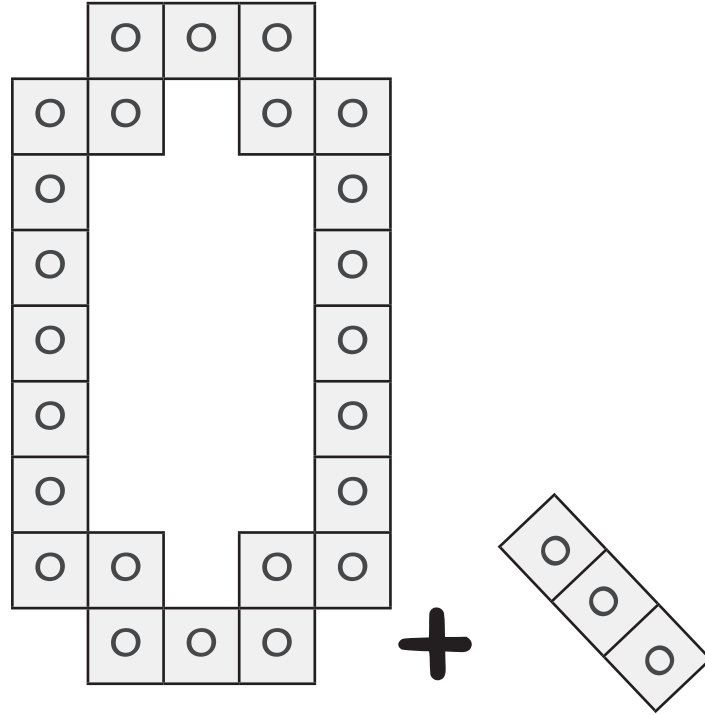

Find

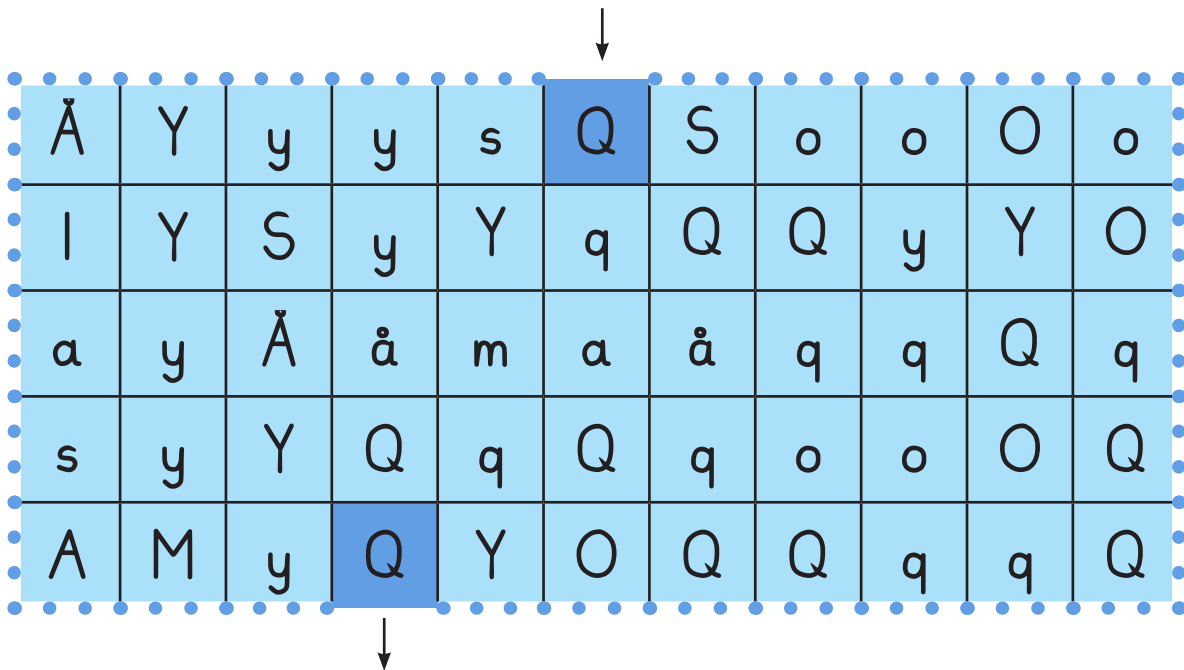

Skriv

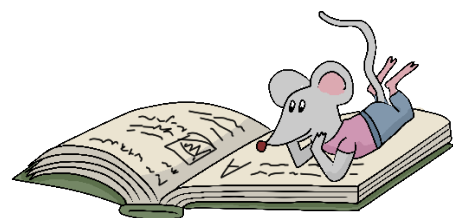
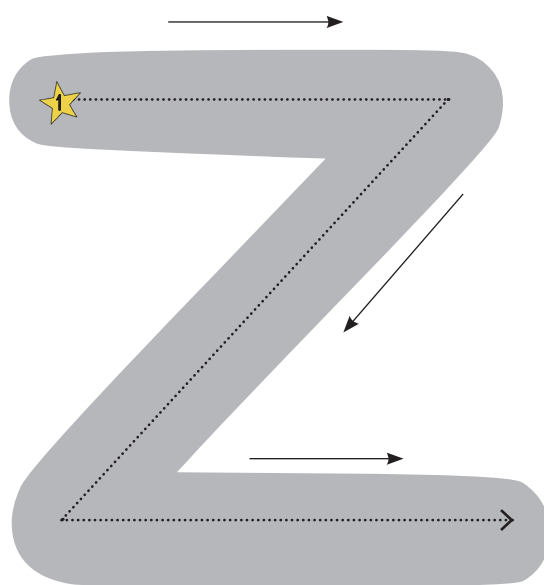
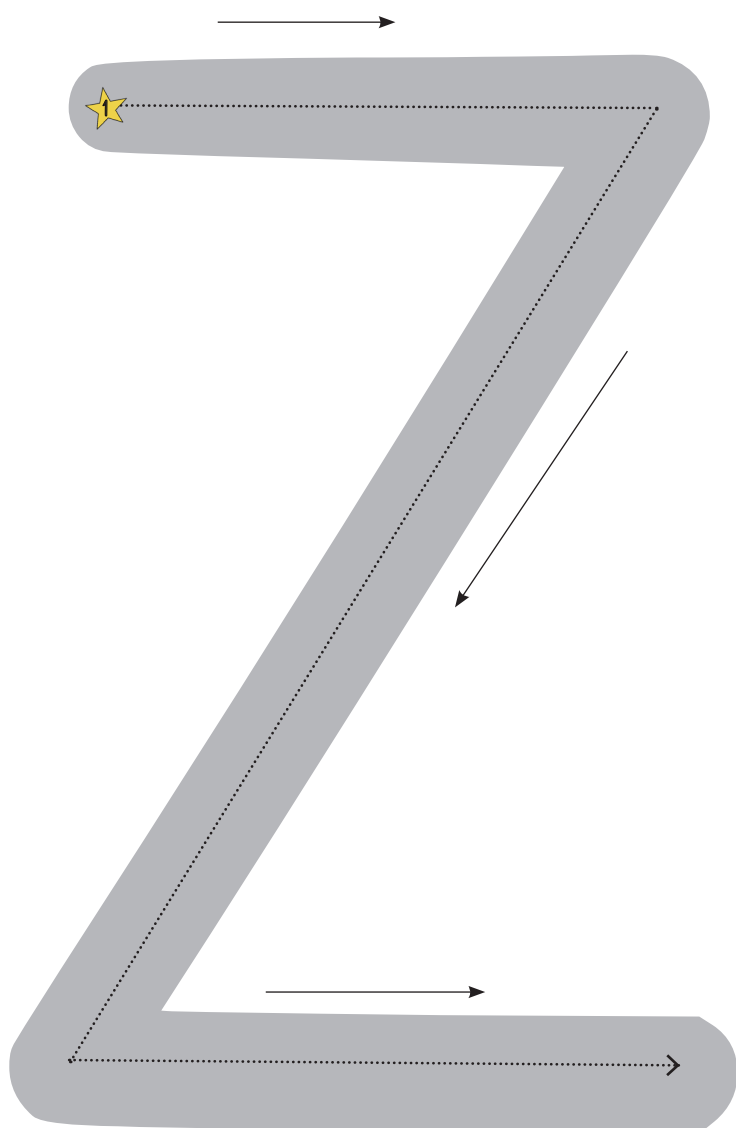

Byg

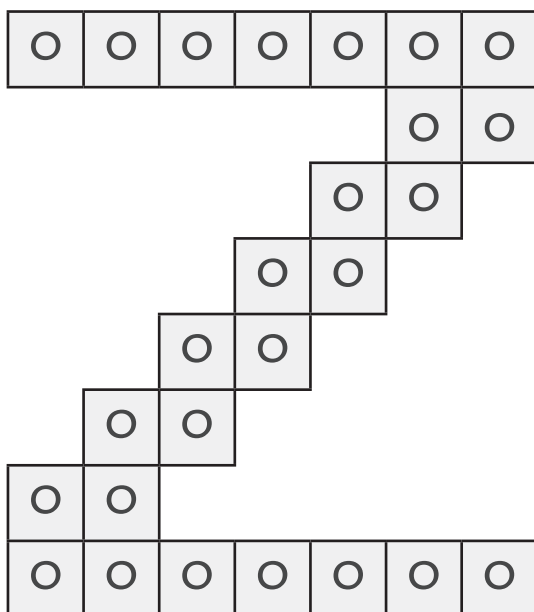

Find

Ä	Y	y	Z	z	Z	S	o	o	O	o
I	Y	S	Z	Y	o	O	Z	z	Z	O
a	y	Ä	z	z	Z	Z	z	I	Z	o
s	y	Y	o	o	O	Y	o	o	z	O
A	M	y	O	Y	O	Z	Z	z	Z	Ä

Skriv

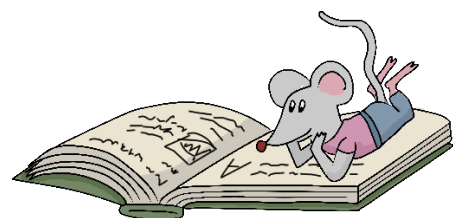
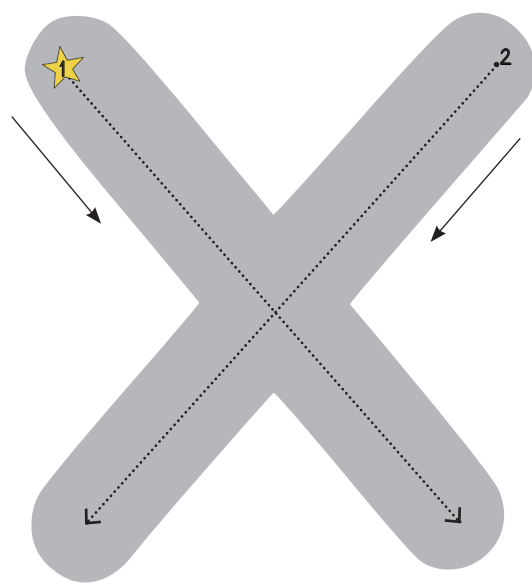
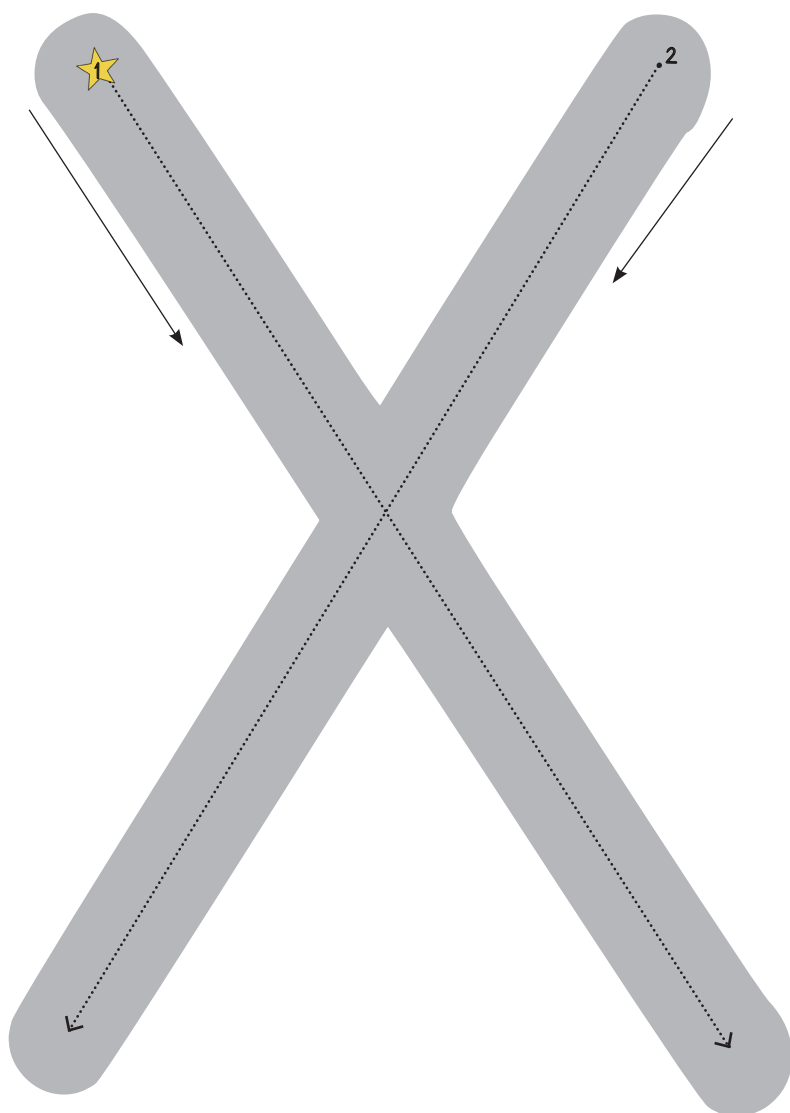

Byg

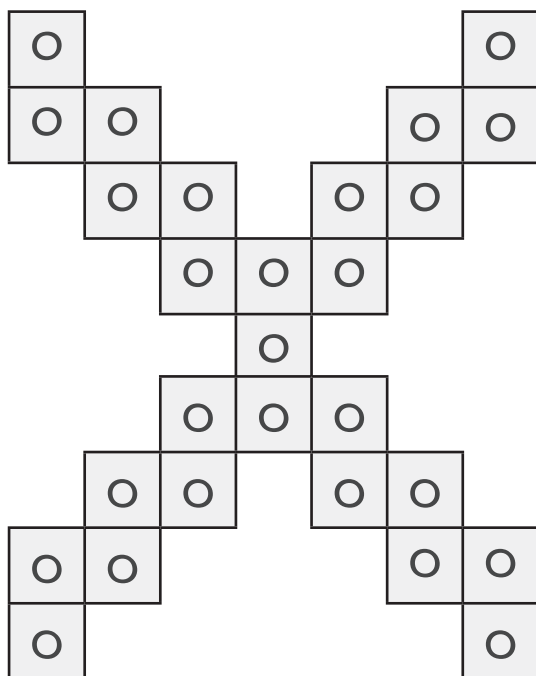

Find

X — D R X H X D X R X

x — x r x d r x d x r

X — R T X R X M X R X

x — x d x h x b x b r