

# Mestersider



Navn:

Klasse:





# Mesterbonus



Skriv bogstaverne på den rigtige plads i alfabetet.

B Y N E T

A B C D E F G H I J K L M N O P Q R S T U V W X Y Z Æ Ø Å





Hvad starter ordet med?

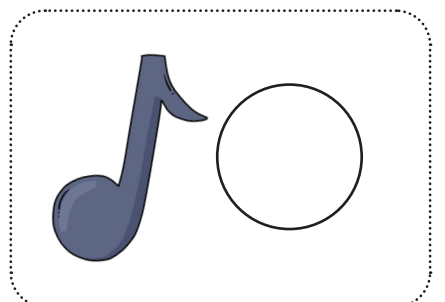
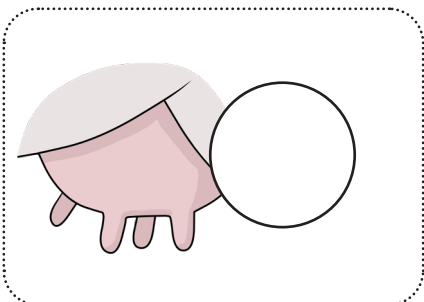
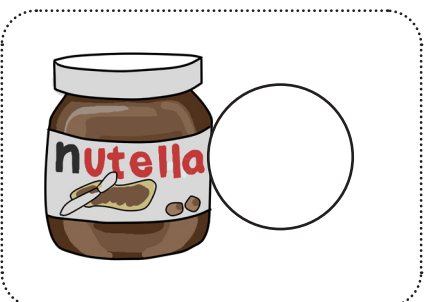
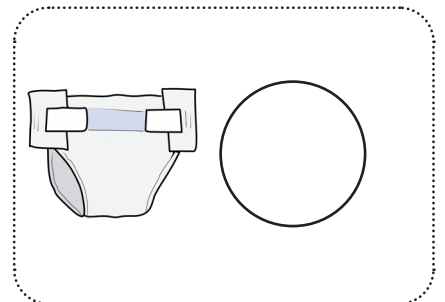
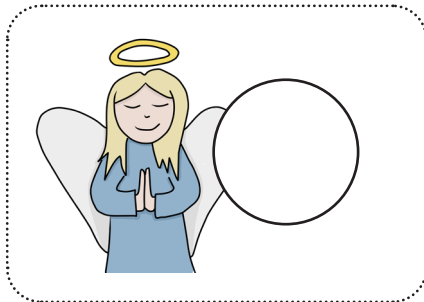
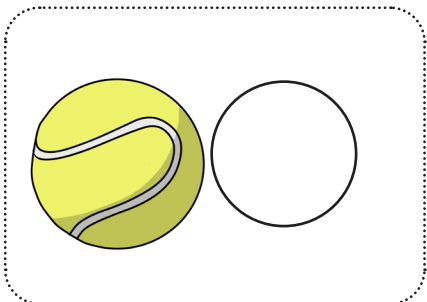
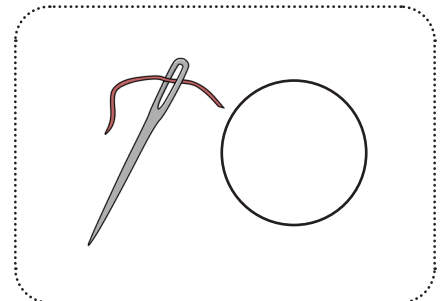
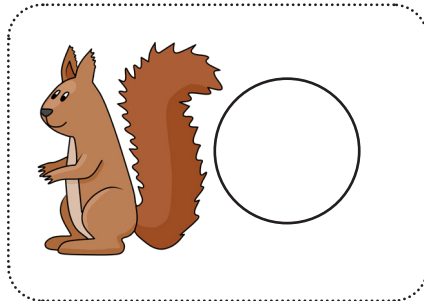
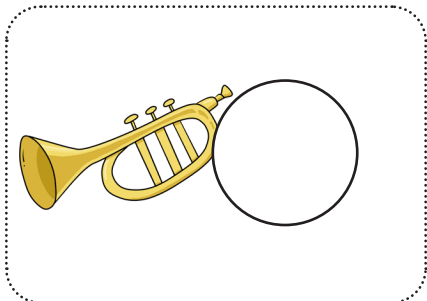
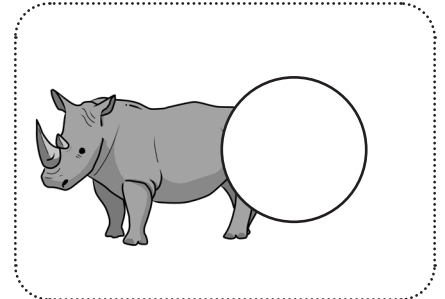
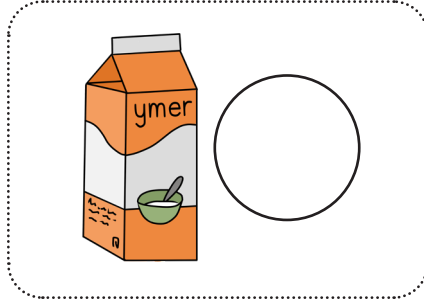
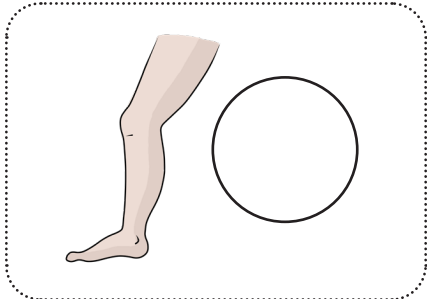



Farv det rigtige ord.



bå

by

eb



te

ty

ta



byn

bil

ben



hi

bi

ni

1

en

ti

bi





Farv den lyd, du kan høre.

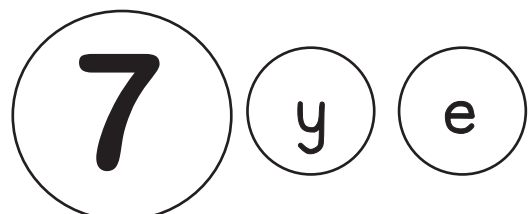
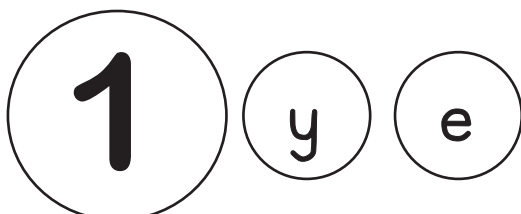
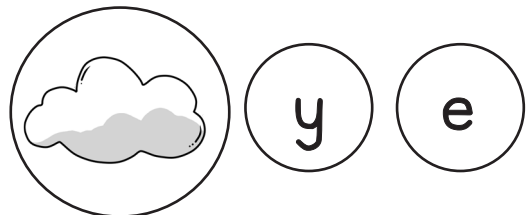
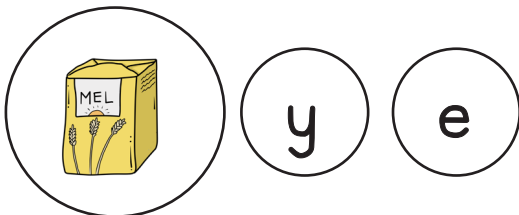
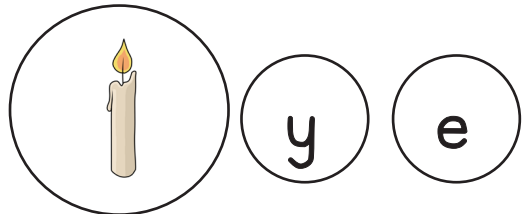
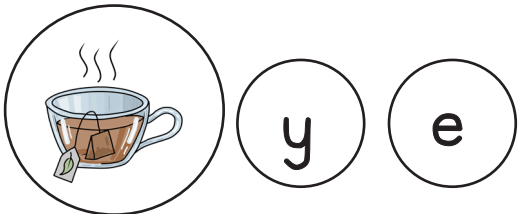
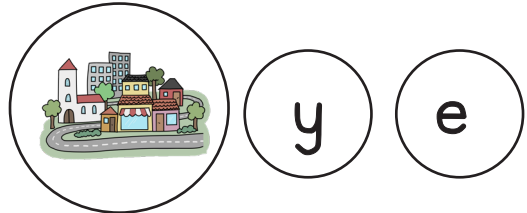
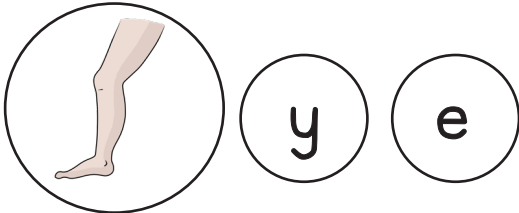
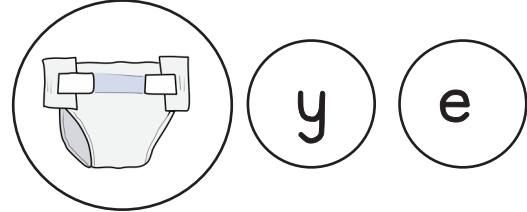
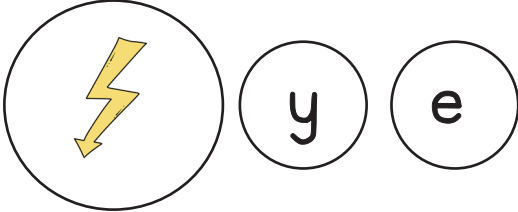



Læs og find.

en



te

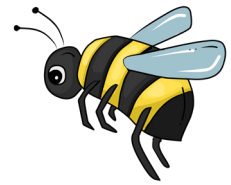

bi



ben



lyn

1

bil





Skriv det bogstav, der mangler.



\_\_ i



b\_\_



\_\_ e

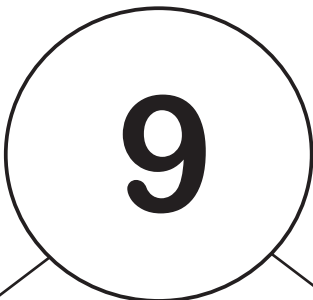

\_\_ i

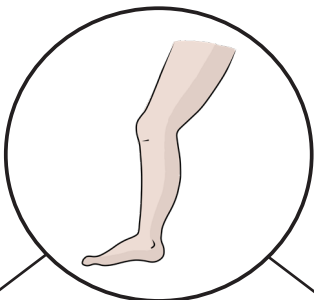

b\_\_ n

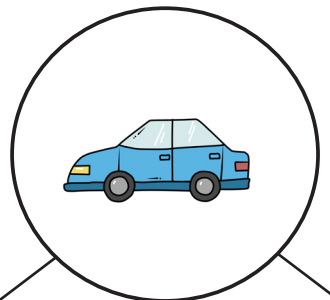

\_\_ il

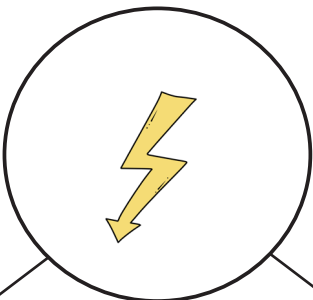

l\_\_ n

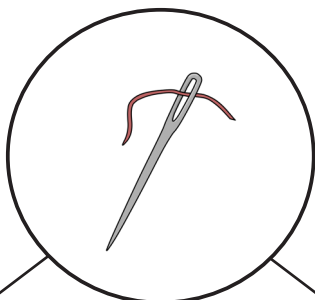

\_\_ å l

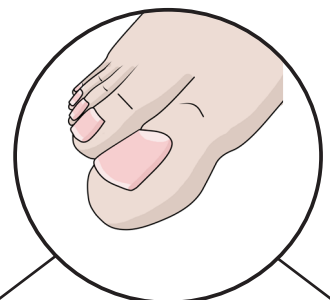

\_\_ å

