

Mestersider



Navn:

Klasse:





Mesterbonus



Skriv bogstaverne på den rigtige plads i alfabetet.

R O Æ D Ø

A B C H I J
 E F G K
 L
 M
 T S P N
 U Q
 V
 W X Y Å
 Z





Hvad starter ordet med?

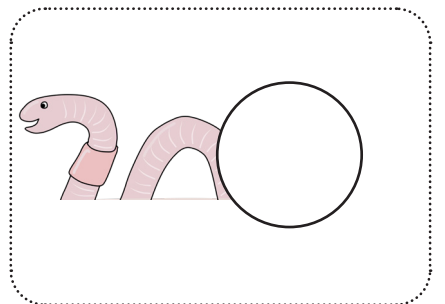
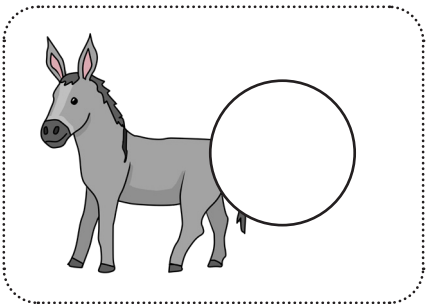
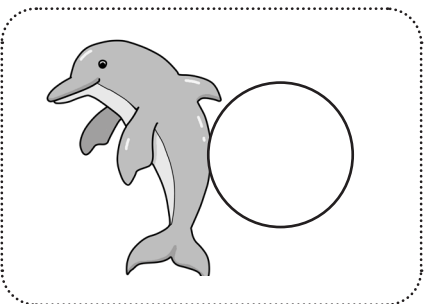
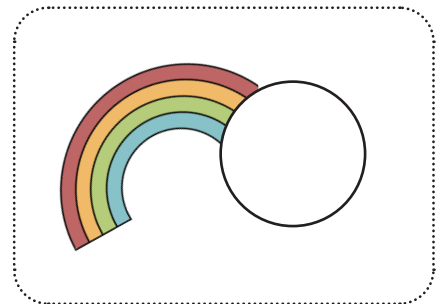
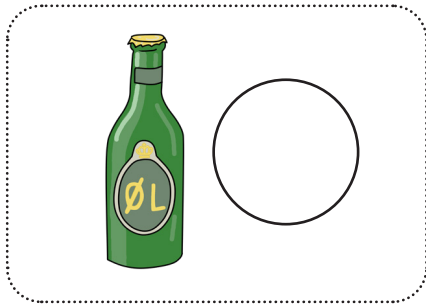
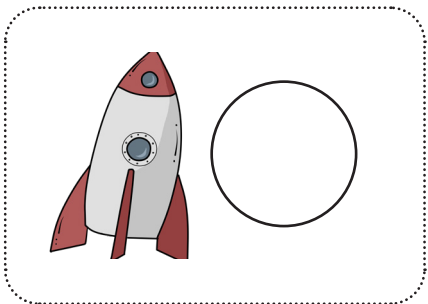
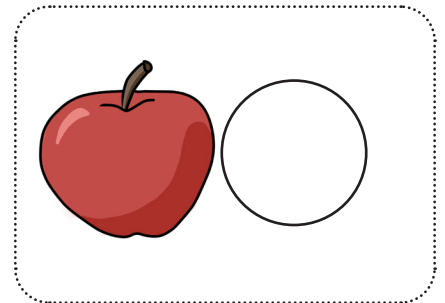
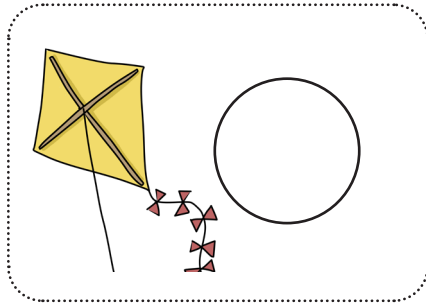
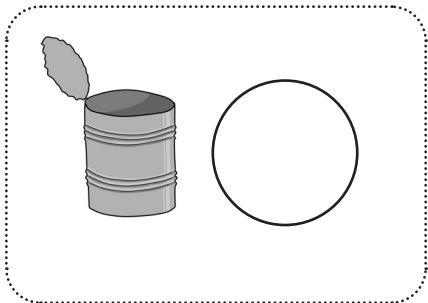
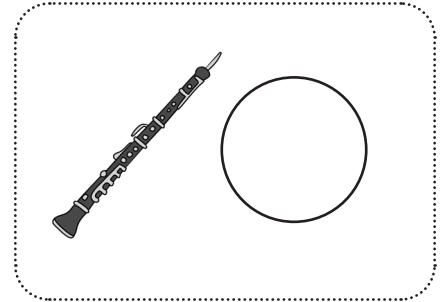
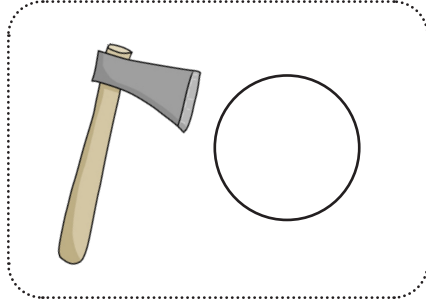
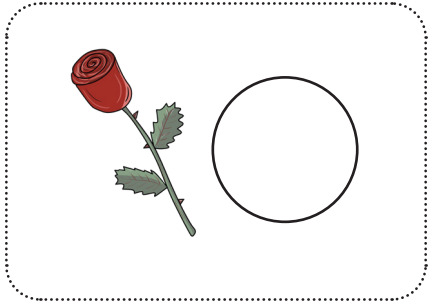



Farv det rigtige ord.



rim

ris

fis



obo

bob

abe

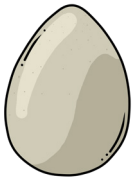

æs

øs

æg

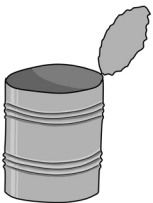

dise

duse

dåse



ål

øl

yl





Farv den lyd, du kan høre.



o

ø

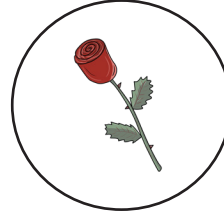

i

o

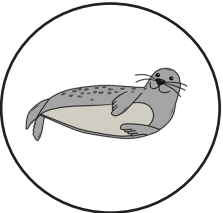

æ

a

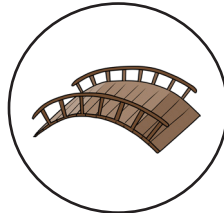

i

o



y

æ



i

o

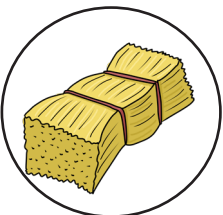

i

ø

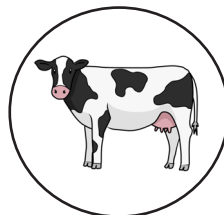

o

å

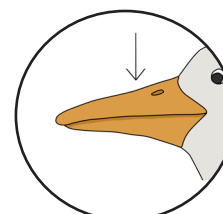

æ

å

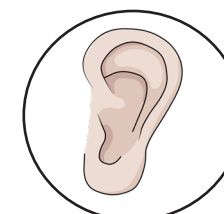

ø

å





Læs og find.

bæ

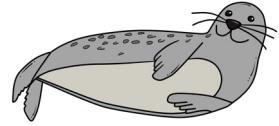

sæl



orm

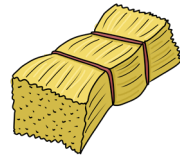

bro



ris



hø

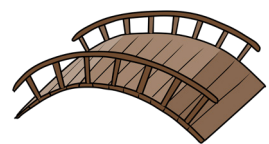



Skriv det bogstav, der mangler.



__ i s

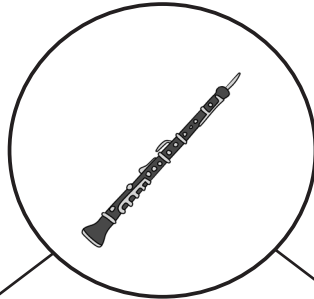

__ b __

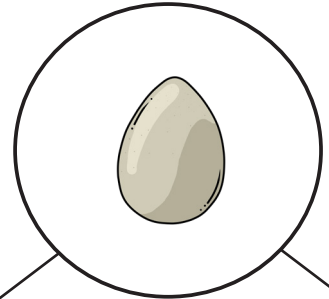

__ g

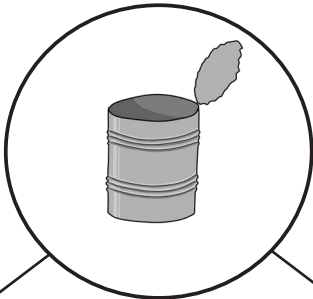

__ å s e

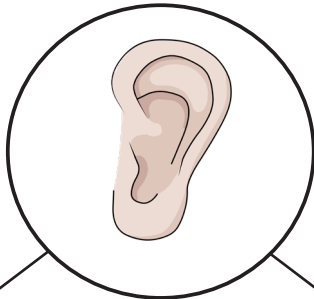

__ r e

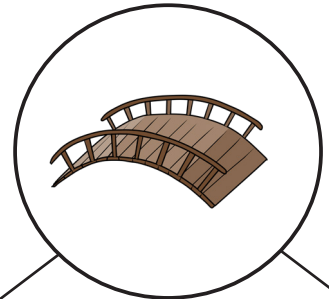

b __ o

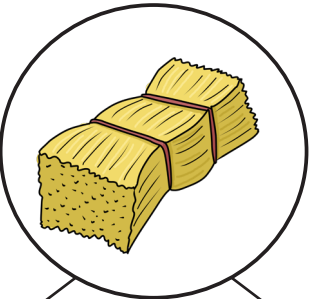

h __

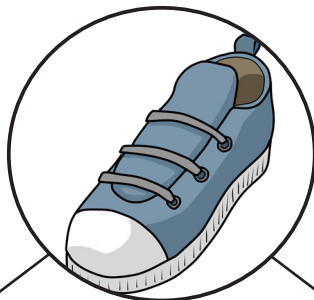

s k __

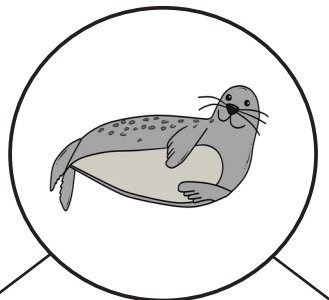

s __ l

